

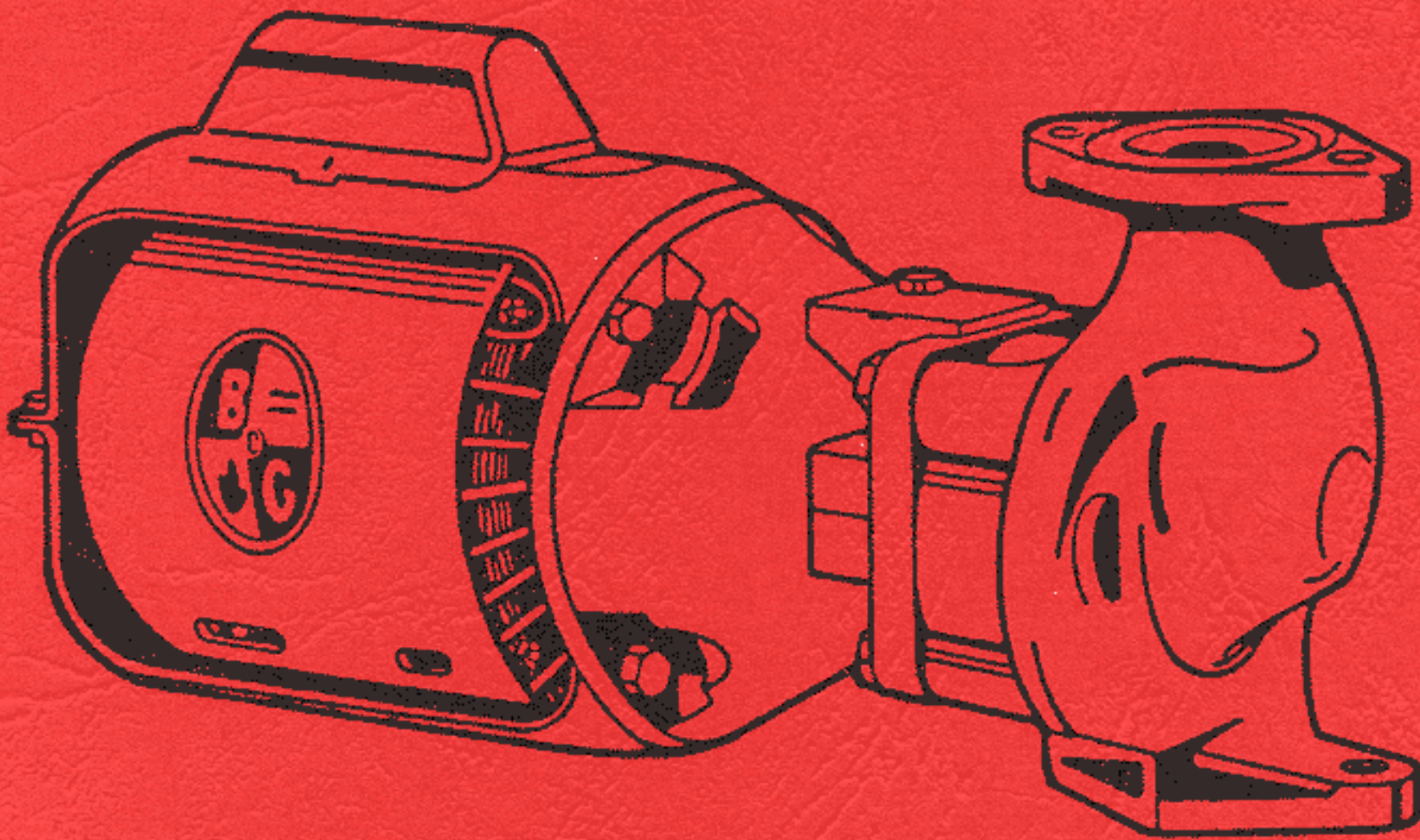

SERVICE MANUAL

HS-105-SM

Revision 3



Booster Pump Service Manual & Troubleshooting Guide

Table of Contents

INTRODUCTION	3
BOOSTER PUMP EXPLODED VIEW	4
1.0 GENERAL FIELD SERVICE	5
1.1 System Preparation	5
1.2 Removing the Conduit Box Cover	6
1.3 Disconnect the Coupler from the Pump Shaft	6
1.4 Separate the Motor from the Bearing Assembly	7
1.5 Removing and Replacing the Coupler	7
2.0 MOTOR MOUNT SERVICE	8
2.1 Motor Mount Replacement	8
2.2 Inspect Motor Mount Wear and Damage	8
2.3 Removing the Motor Mount – Outer Ring	9
2.4 Removing the Motor Mount – Inner Ring	9
2.5 Replacing the Motor Mount	10
2.6 Completing Motor Mount Service	10
3.0 BEARING ASSEMBLY SERVICE	11
3.1 Removing the Bearing Assembly	11
3.2 Disengage the Bearing Assembly	11
3.3 Removing the Impeller	12
3.4 About the Impeller, Washer and Spring	12
3.5 Removing the Mechanical Seal	12
3.6 Removing the Oil Cover	13
3.7 Removing the Oil Wick	13
3.8 Beginning Disassembly of the Front Bearing	13
3.9 Removing the Front Bearing	14
3.10 Examine the Bearing and Pump Shaft	14
3.11 Cleaning the Shaft's Copper Sleeve	14
3.12 Beginning the Reassembly of the Bearing	15
3.13 Securing the Front Bearing	15
3.14 Installation of the Oil Wick	16
3.15 Replacing the Mechanical Seal	16
3.16 Clean the Seat of the Mechanical Seal	16
3.17 Installing the Mechanical Seal	17
3.18 Final Assembly of the Seal	17
3.19 Replacing the Impeller	17
4.0 REASSEMBLY OF THE SYSTEM PUMP	18
4.1 Inspect and Clean the Pump Body	18
4.2 Installing a New Pump Body Gasket	18
4.3 Aligning the Bearing Assembly	19
4.4 Attaching the Coupler	19
4.5 Installing the Motor	19
5.0 RESTARTING THE SYSTEM	20
5.1 Filling and Venting the System	20
5.2 Connecting the Electrical Power	20
6.0 SPECIAL CONSIDERATIONS	21
6.1 Proper Oiling Procedures	21
6.2 Bronze Body Boosters	21
PUMPING SYSTEM TROUBLE ANALYSIS GUIDE	22-23
B&G FACTORY GUARANTEED REPLACEMENT PARTS	24

INTRODUCTION

This manual demonstrates the proper servicing techniques for Bell & Gossett Booster Pumps. B&G Boosters have been designed to give many years of trouble free operation with periodic maintenance limited to lubrication. However, should repair become necessary, service techniques illustrated and explained in this manual should be followed to provide safe and efficient methods of repair.

Repair procedures are outlined in a step-by-step fashion with pictures included to provide instructional clarity and accuracy. In the event that replacement parts are required, each item listed within this manual can be cross referenced to the B&G Booster Parts List.



SAFETY INSTRUCTION

This safety alert symbol will be used in this manual and on the pump instructions decal to draw attention to safety related instructions. When used, the safety alert symbol means ATTENTION! BECOME ALERT! YOUR SAFETY IS INVOLVED! FAILURE TO FOLLOW THE INSTRUCTIONS MAY RESULT IN A SAFETY HAZARD.

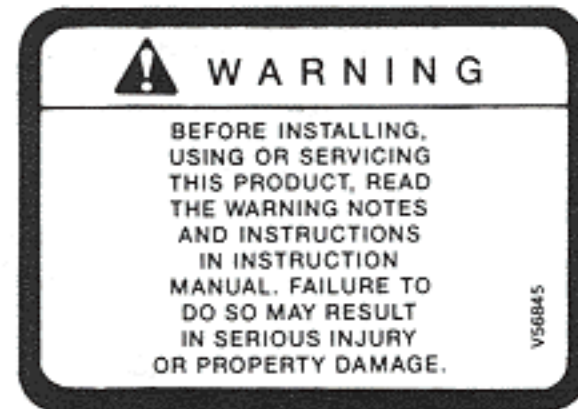

Your Booster Pump should have this warning label affixed to the pump near the conduit box cover. If this warning is missing or illegible, contact your local Bell & Gossett Representative for a replacement.

Pump Application

Bell & Gossett Booster Pumps may be used for water circulating applications in hydronic, solar and chilled water systems. If equipped with a bronze pump body, Bell & Gossett Booster Pumps may be used for water circulation in potable water systems. Note that some local codes require using a check valve in the supply line when recirculating potable water. If a supply line check valve is installed, a properly sized and located compression tank and pressure relief valve is required.

WARNING: Excessive Pressure Hazard-Volumetric Expansion

The heating of water and other fluids causes volumetric expansion. The associated forces may cause failure of system components and release high temperature fluids. This will be prevented by installing properly sized and located compression tanks and pressure relief valves. Failure to follow these instructions could result in serious personal injury, death and/or property damage.

1. Electrical connections are to be made by qualified electricians in accordance with all national, state and local codes.

WARNING: Electrical Shock Hazard

Electrical Connections must be made by a qualified electrician in accordance with all applicable codes, ordinances and good practices. Failure to follow these instructions could result in serious personal injury or death and property damage.

2. B&G Booster Pumps are designed to pump liquids compatible with their iron or bronze body construction at working pressures up to 125 psi at a maximum temperature of 225°F. Do not exceed these values.

WARNING: Excessive Pressure Hazard

The maximum working pressure of the pump is listed on the nameplate, do not exceed this pressure. Failure to follow these instructions could result in serious personal injury or death and property damage.

3. This pump is for indoor use only.

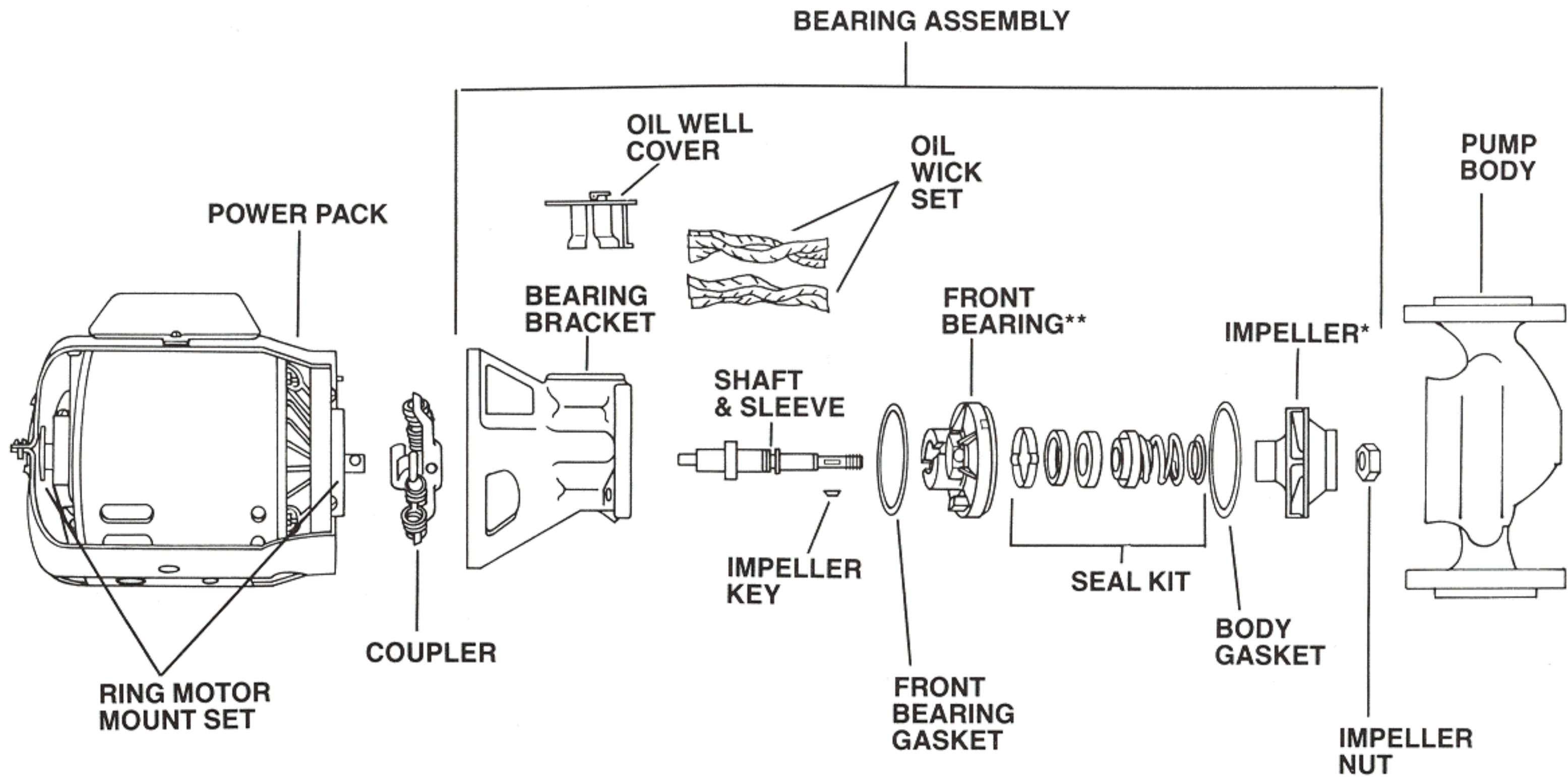

Booster Pump

Exploded View

NOTE: Pump shown is Series 100. Replacement parts for all boosters are similar.

*- Impeller not always included in Bearing Assembly.

**-Shown rotated 90°

1.0 GENERAL FIELD SERVICE

Instructions for service procedures to be carried out in the field are demonstrated in this section. Steps of assembly and disassembly are in the order in which they will be encountered by servicepersons. The names of the parts listed within this manual are the same as those listed on the B&G Parts Lists. All service operations can be completed with common hand tools. These instructions have been written to specifically reflect the Series 100, HV, PR and 2" booster pumps. References to certain features such as over/under motor brackets and plastic impellers do not apply to all booster pumps.

Note: Removal of the pump body from the system is not necessary unless the flange gaskets are leaking or the pump body itself is damaged. In either case, it will not be necessary to remove the flanges.

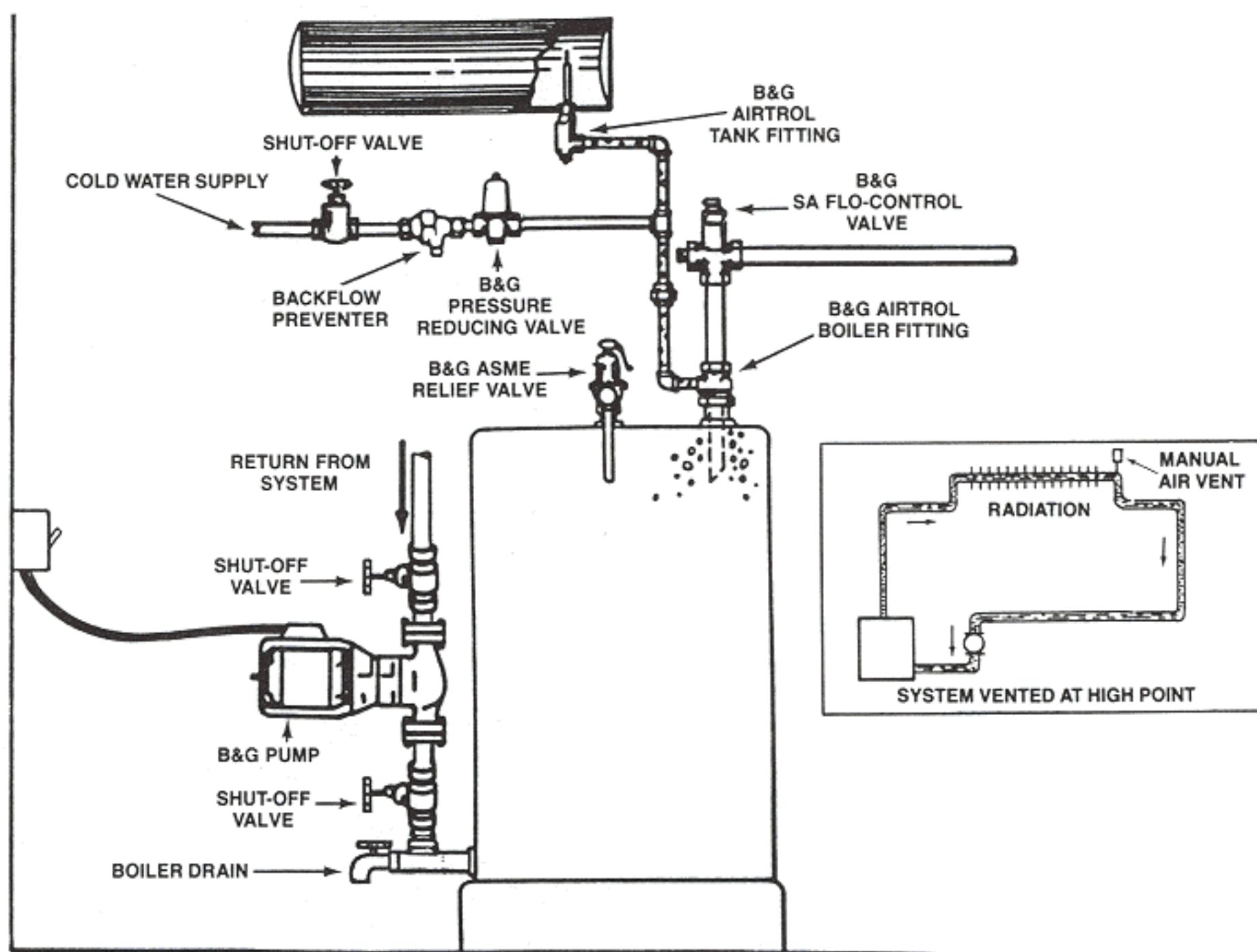

1.1 System Preparation

The electrical supply must be turned off and the pump service valves must be closed before servicing procedures begin. If no service valves are installed, the city water supply valve should be closed.



WARNING: Hot Water Hazard

Before draining the system, allow water to cool to at least 100°F, open the drain valve (take precautions against water damage) and leave the drain valve open until servicing is completed. Failure to follow these instructions could result in serious personal injury and/or property damage.

The system should then be drained by opening the boiler drain valve and the vent near the top of the system. If a Flo-Control valve is installed and there are balance valves on the returns, then the balance valves may be closed to isolate the boiler from the system. The Flo-Control valve will act as a check valve on the supply and only the boiler will need to be drained. Open a vent between the boiler and the system.

1.2 Removing the Conduit Box Cover

⚠ WARNING: Electrical Shock Hazard
Disconnect and lockout the power before servicing. Failure to follow these instructions could result in serious personal injury or death.

⚠ WARNING: Electrical Shock Hazard
Be certain the electrical power is not present at the motor leads before continuing. Failure to follow these instructions could result in serious personal injury or death.

⚠ WARNING: Unexpected Start-Up Hazard
Single phase motors are equipped with automatic reset overload protectors. The pump can restart without warning. Disconnect and lockout power before servicing. Failure to follow these instructions could result in serious personal injury or death.

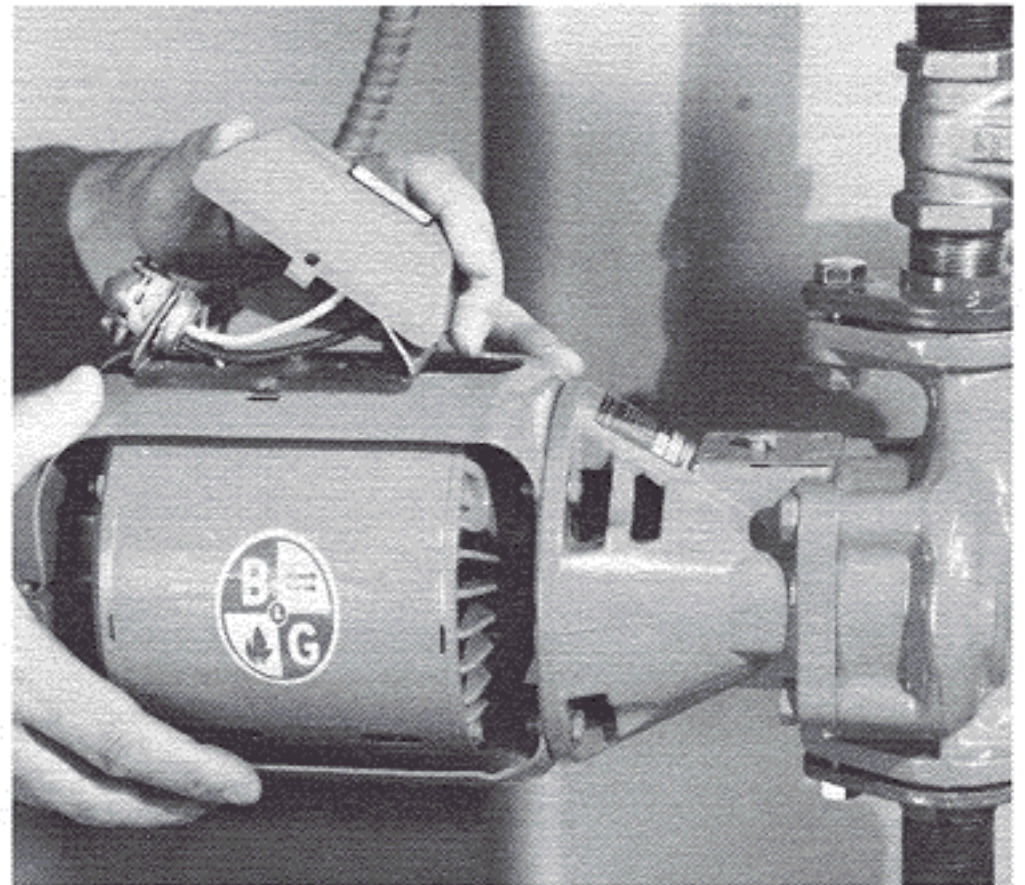

The conduit box cover must be removed and all electrical wires must be disconnected prior to separating the motor from the bearing assembly. The photograph illustrates the removal of the conduit box cover. This procedure is followed by the removal of the wire nuts and the flexible conduit connector.

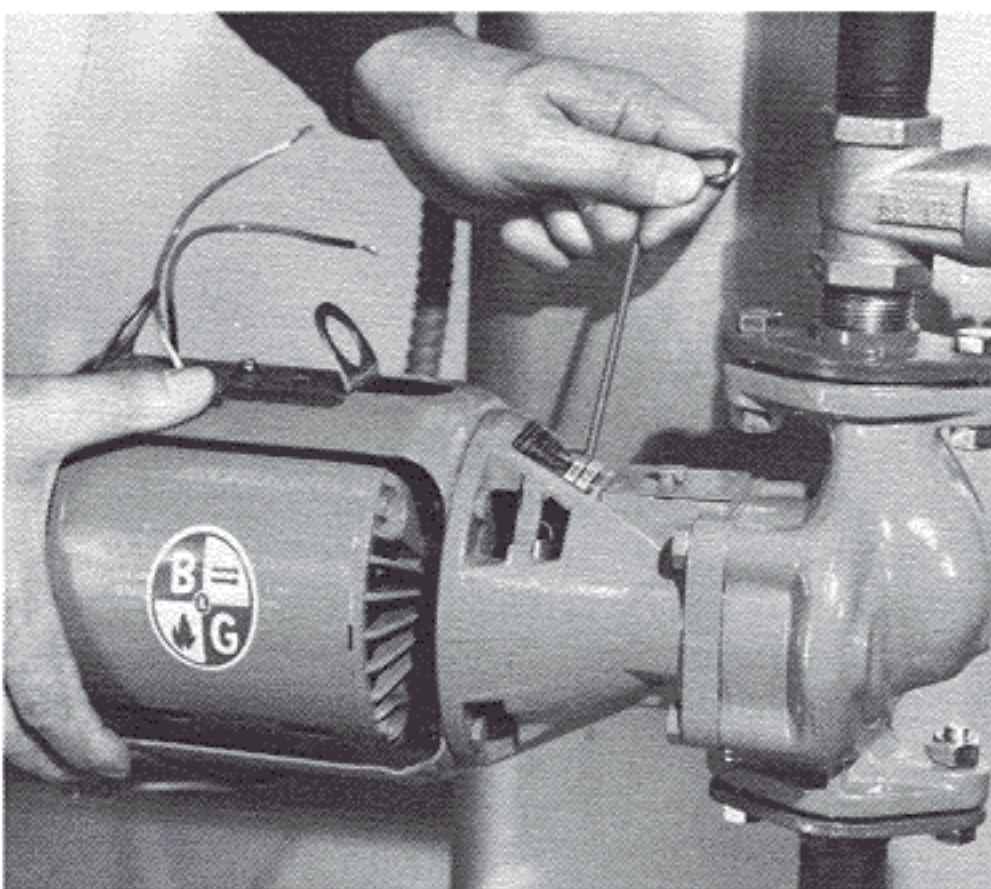

1.3 Disconnect the Coupler from the Pump Shaft

The coupler is released from the pump shaft by loosening the set screw with an Allen wrench. The set screw rests in a blind hole along the shaft; the set screw must therefore be backed off at least $\frac{1}{8}$ " before attempting to remove the coupler. If stuck, a screwdriver may be used to gently pry the coupler from the shaft (before prying, be certain that the set screw has cleared the depth of the blind hole — usually about three full turns of the wrench will clear the hole).

1.4 Separate the Motor from the Bearing Assembly

Support the motor assembly before beginning this procedure. Use a box wrench to loosen and remove the four motor cap screws connecting the motor to the bearing assembly.

With the cap screws removed, the motor can be separated from the bearing assembly. Provided that the coupler set screws were backed off sufficiently, the coupler should slide free of the pump shaft. If tight, a screwdriver may be used to gently pry the coupler loose.

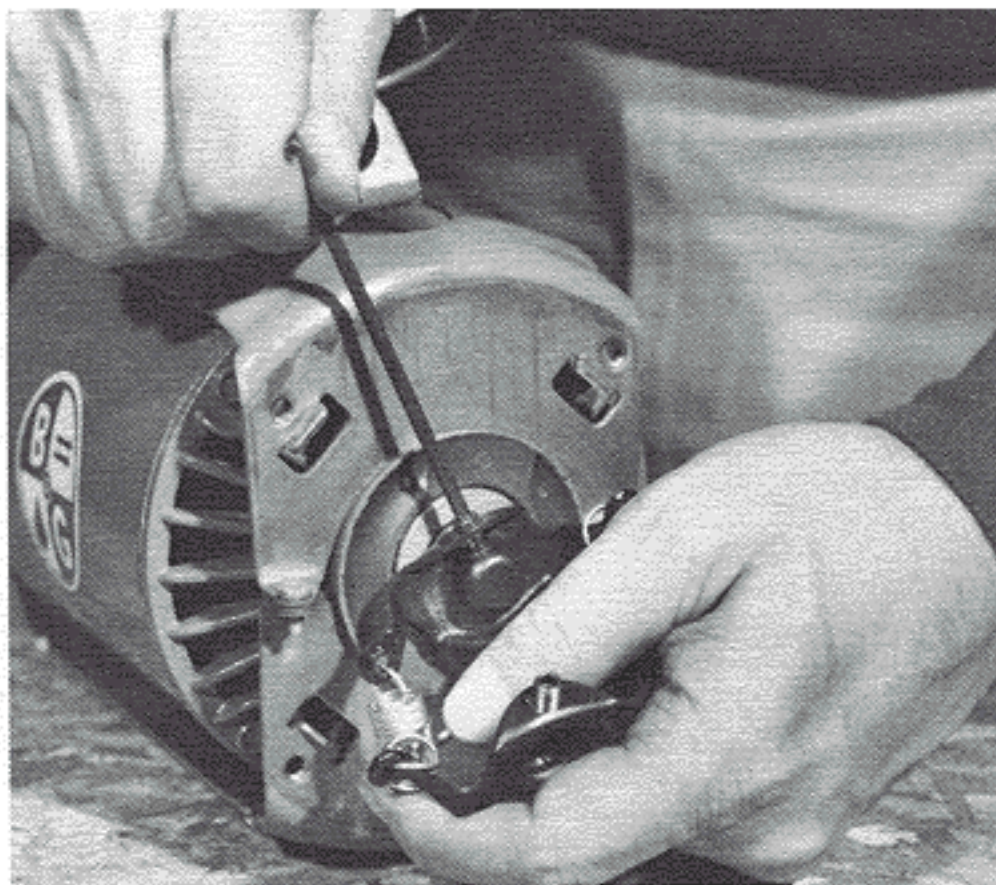
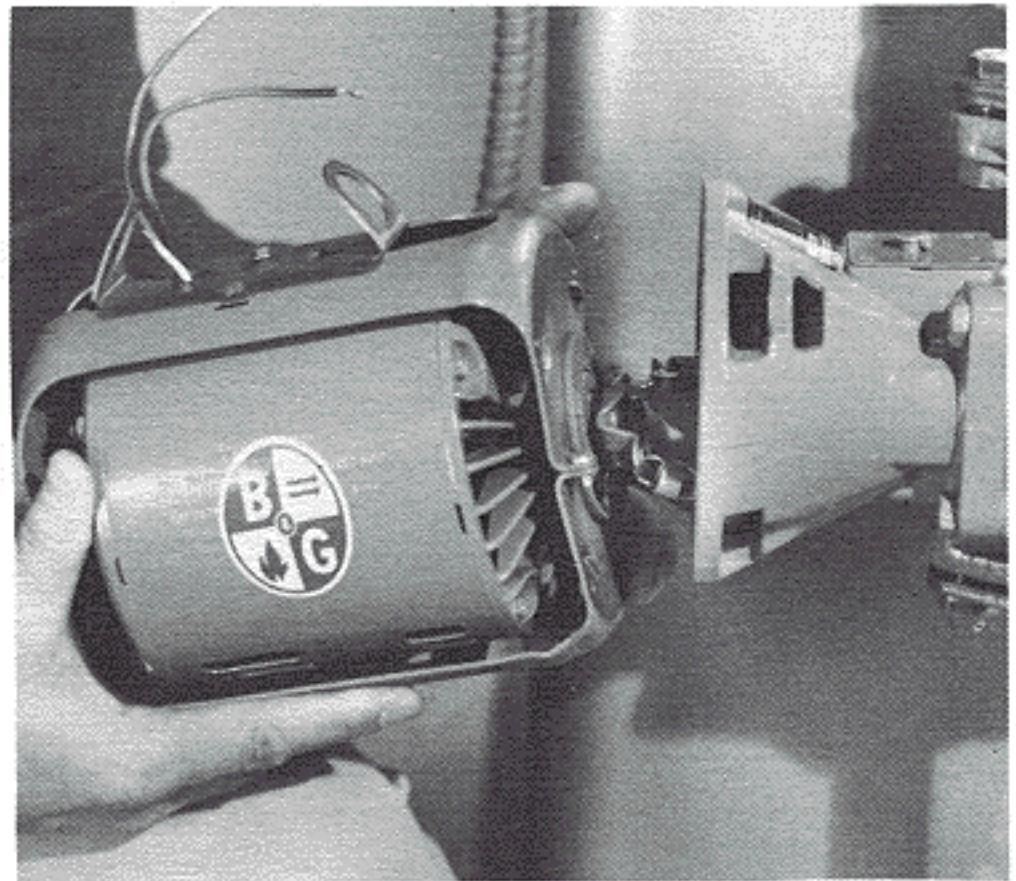

1.5 Removing and Replacing the Coupler

Similar to its removal from the pump shaft, the coupler is separated from the motor shaft by loosening the set screw with an Allen wrench. If the coupler is found to be broken completely or if excessive wear is observed, replace the entire coupler — never replace individual components of the coupler assembly. Neither the springs nor the coupler arms should ever be replaced. Replacing individual springs will only result in repeated breakage due to spring imbalance caused by the greater stiffness of the new springs compared to the old ones.

Note: Noisy coupler operation or coupler failure are generally strong indicators of the need to replace the motor mounts. Refer to Section 2.0 for motor mount servicing instructions.

New couplers can be installed by reversing the removal operation. The set screw must be seated in the shaft recess to prevent slipping.

2.0 MOTOR MOUNT SERVICE

The following procedures illustrate and explain the operations that can be performed in the field. These operations are limited to the exterior of the motor. All repair work to the motor's interior should be performed by an authorized Bell & Gossett Motor Repair Station. Information regarding the nearest B&G repair station can be obtained from your local B&G Representative.

2.1 Motor Mount Replacement

The over/under brackets must be removed prior to servicing the motor mounts. These brackets can be separated by first removing the four clamp screws (there are two screws at each end of the motor) and then lifting one half from the other. This operation will leave the free standing motor.

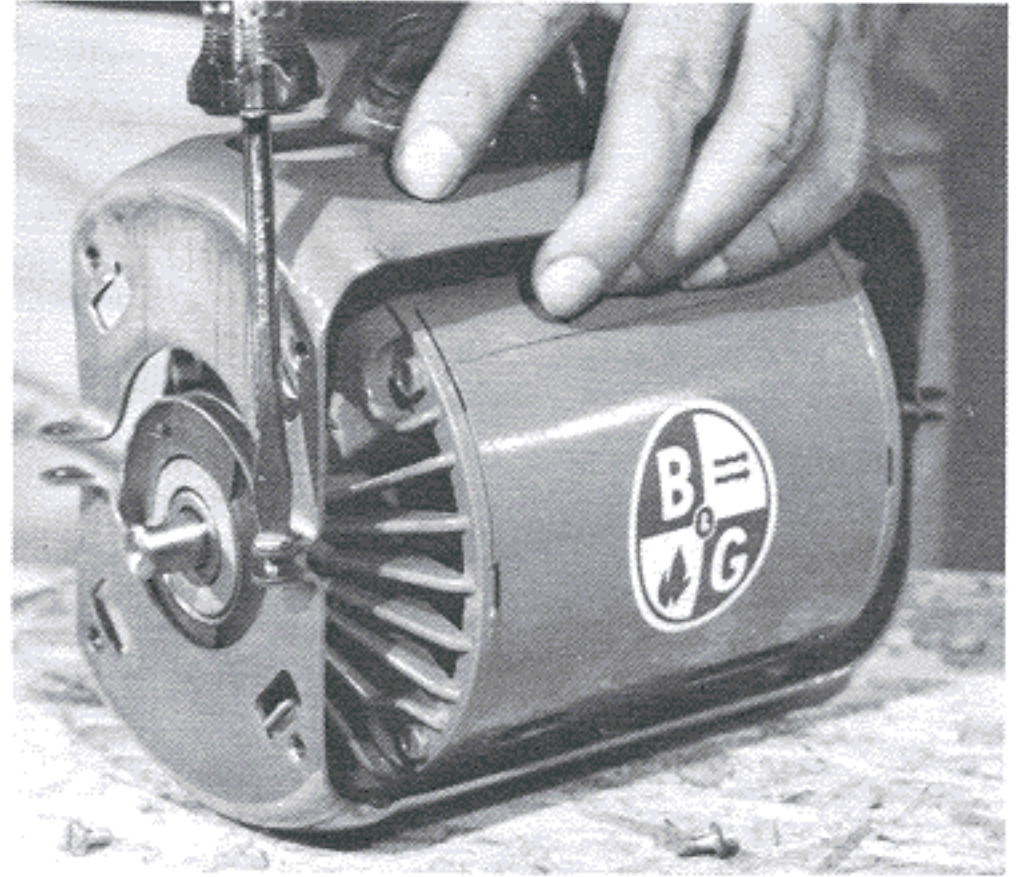

2.2 Inspect Motor Mount Wear and Damage

Always visually inspect the motor mounts before removing them from the end plates. An inspection in-place may give some indication to the cause of an operational problem or failure.

The motor mount in the photograph displays the effects of over-oiling. Though B&G motor mounts are made of neoprene, an oil resistant compound, constant oil soaking will eventually produce material damage. This mount has been damaged and has begun to sag as a result.

Always replace both motor mounts when either one shows signs of sagging. Never replace one mount at a time. Single replacements will only result in misalignment of pump and motor shafts.

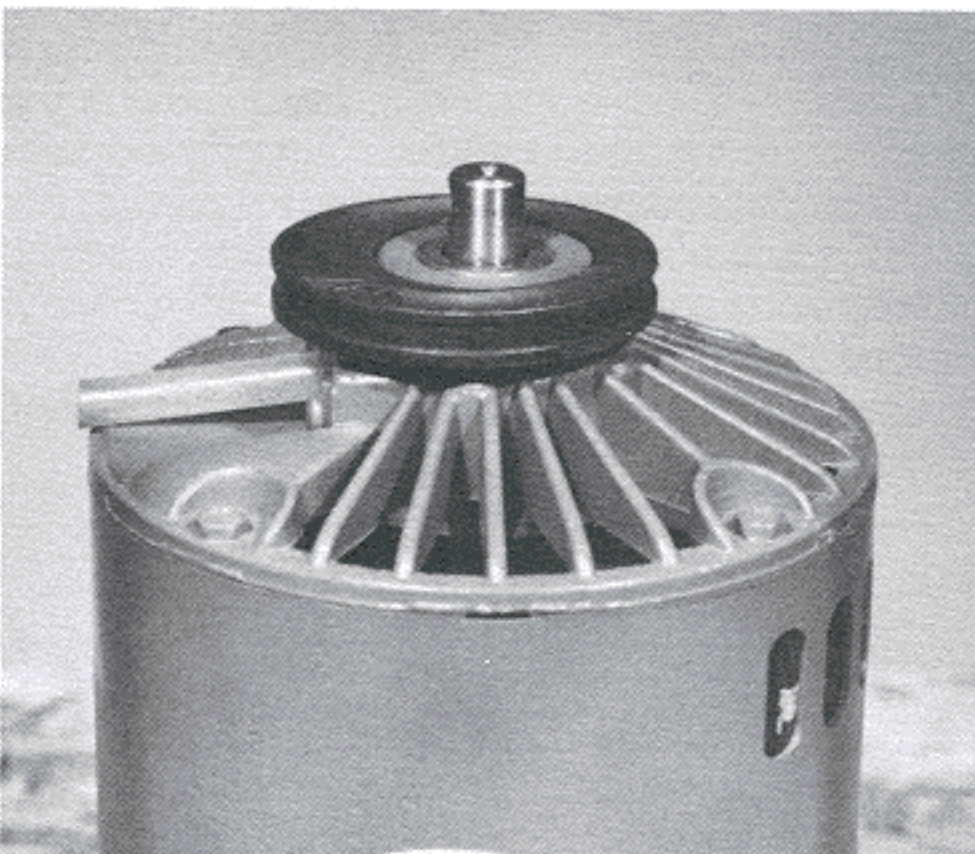

2.3 Removing the Motor Mount – Outer Ring

The motor mount's outer ring can be removed by using a hammer and screwdriver. As shown, place the screwdriver between the front mounting and the end plate of the motor; the head should be angled inward toward the mount's rubber section. Tap the screwdriver to force it through the rubber.

The screwdriver can now be used to pry against the inner ring of the mount to remove the outer ring. Care should be taken during this operation to prevent damage to the motor shaft or end plates.



2.4 Removing the Motor Mount – Inner Ring

The inner ring of the motor mount, which should not come off with the outer ring, will require an additional effort for its removal. B&G suggests the use of either a cold chisel to cut through the inner ring or a means of prying the ring from the end plate. In both cases, however, care must be taken to prevent damage to the motor itself and/or the motor end plates.

2.5 Replacing the Motor Mount

Remember to always replace both mounts whenever one of the mounts begins to sag — never replace one mount and not the other. Replace the front mount first and then the rear mount. To correctly position a replacement mount, set it square on the boss of the motor end plate as shown.

Orient the mount so that the split along its outer diameter is aligned to the bottom of the motor (direction opposite the oil tube). With the mount positioned and aligned properly, use a hammer to tap around the mount until it sits flush against the end plate. Repeat the procedure for the rear mount.

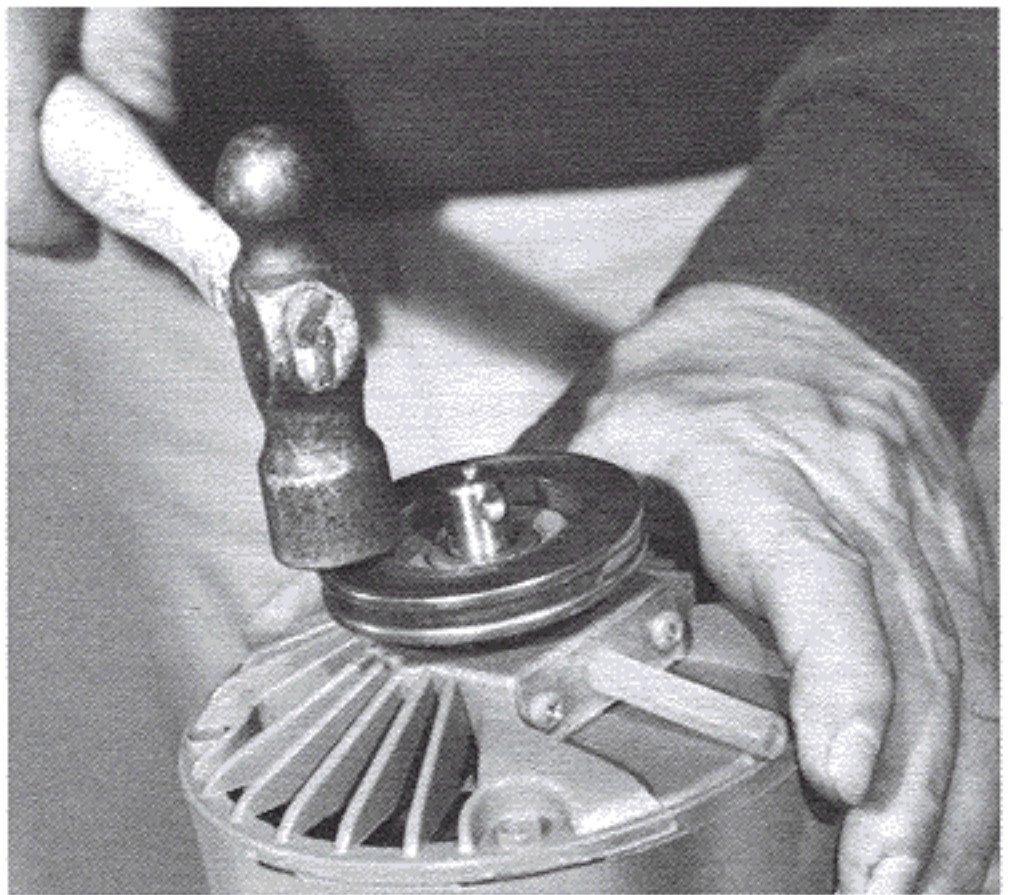

2.6 Completing Motor Mount Service

Wipe any debris or oil that may have settled on the over/under brackets. Set the motor into the under bracket so that the two threaded holes in the bracket's end face the same direction as the motor shaft. Pull the ground wire over the top of the rear mount as shown and place the over bracket with its tabs also facing the front of the motor. The ground wire should now extend out from between the over bracket and the motor mount.

Place and tighten the four bracket screws so the motor fits securely between them. It should not be possible to rotate the motor once it is mounted in the brackets.

3.0 BEARING ASSEMBLY SERVICE

Do not begin service to the bearing assembly without first following the procedures of 1.0 – General Field Service. The operations detailed in 1.0 must be completed before the following steps can be taken.



WARNING: Hot Water Hazard

Check surface temperatures. Allow water to cool to at least 100°F before proceeding with any operation related to the bearing assembly. Failure to follow these instructions could result in serious personal injury and/or property damage.

3.1 Removing the Bearing Assembly



CAUTION:

Pressure may be present in the pump body. This pressure can be relieved by loosening the four flange bolts and shifting the position of the bearing assembly slightly to allow the pressurized water to escape. Failure to follow these instructions could result in property damage and/or moderate personal injury.

There are four bolts located in the corners of the bearing assembly attaching it to the pump body. Loosen these bolts evenly while shifting the assembly to relieve any pressure existing in the pump body.

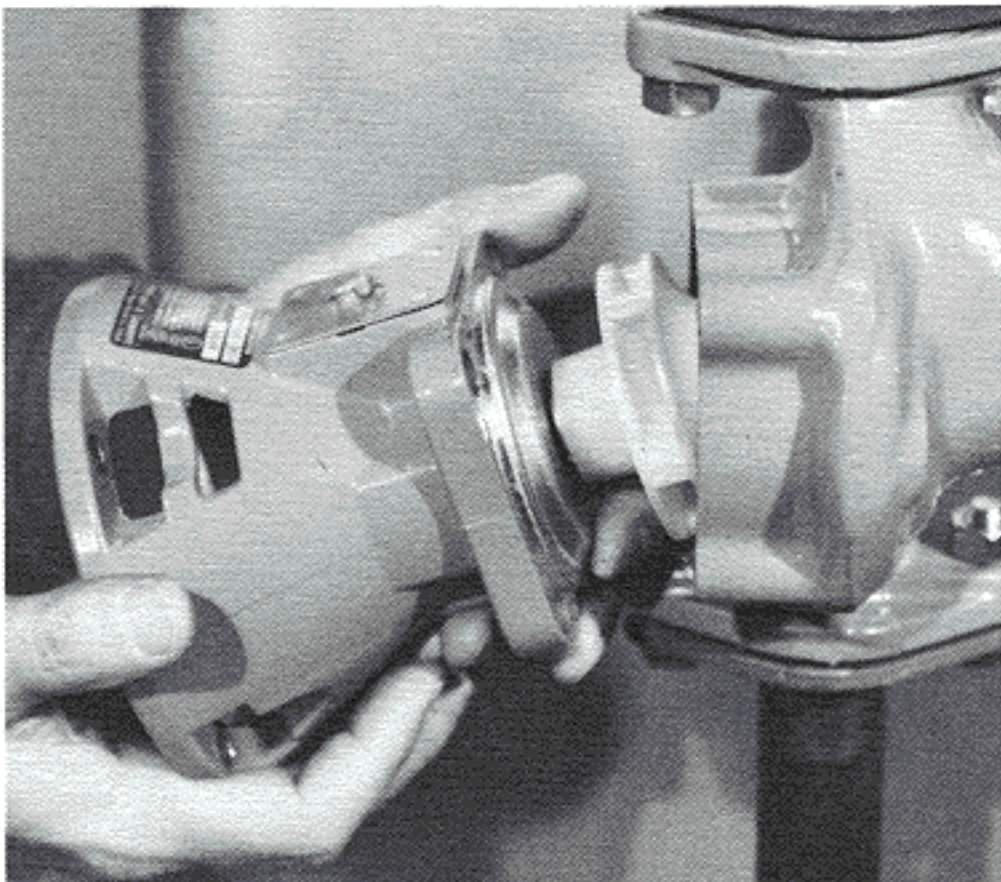
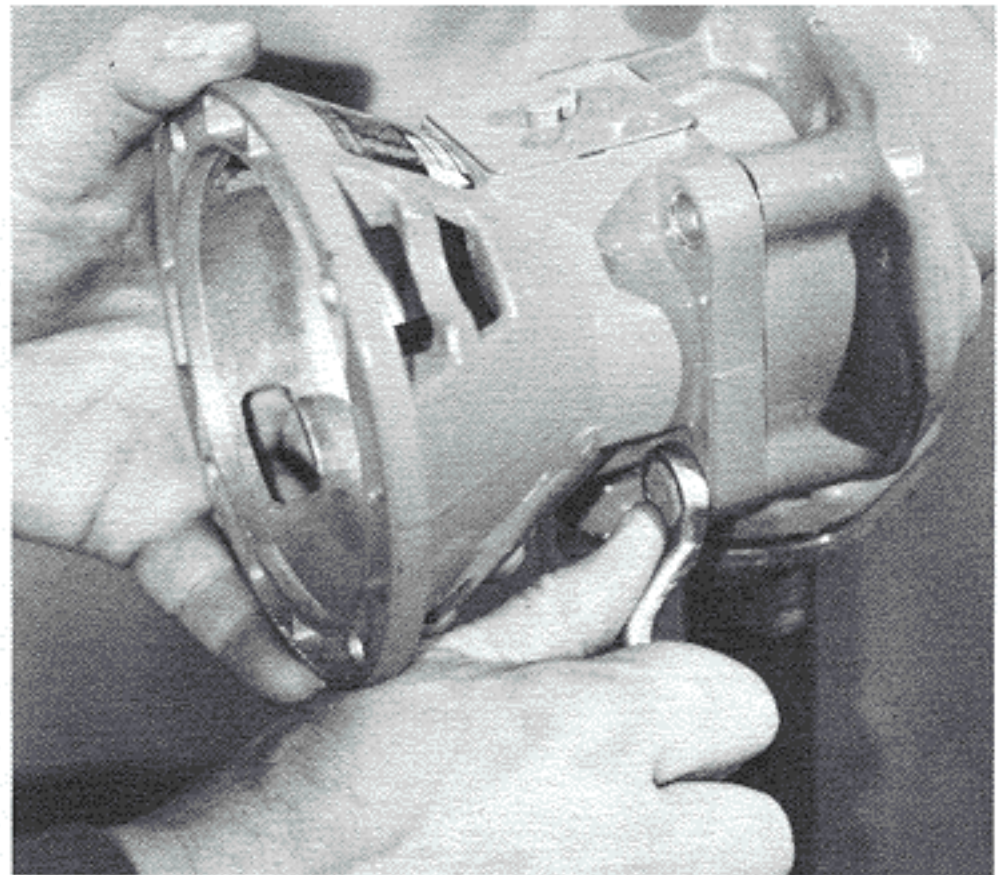

3.2 Disengage the Bearing Assembly

To separate the bearing assembly from the pump body, grasp the assembly on both sides and pull straight back. Do not cock the assembly to one side or the other for this may cause impact damage to the impeller. If the two bodies adhere to each other, insert a screwdriver between the faces and gently pry around the surfaces to break the seal.

3.3 Removing the Impeller

The impeller must first be removed in order to replace the seal, shaft or front bearing. To do this, grasp the impeller to prevent it from turning with one hand while loosening the impeller nut with the other. It is strongly recommended that a strap wrench or rag be used to hold the impeller in place. A socket wrench or an offset box wrench can be used to loosen the nut.

Once the nut is removed, attempt to lift the impeller. If it adheres to the shaft, gently tap the shaft with a screwdriver handle while pulling upward on the impeller. Scale buildup between the shaft and the impeller is often caused by the moving fluid during operation.

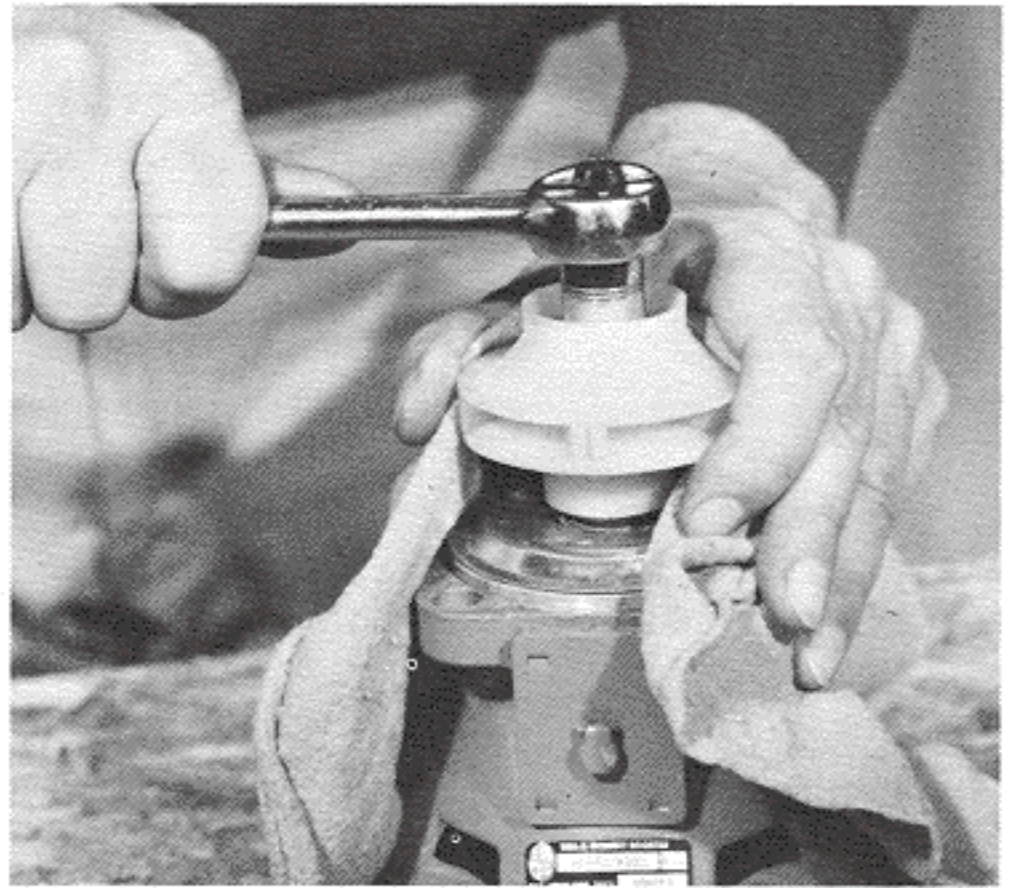

3.4 About the Impeller, Washer and Spring

An improved two-piece plastic impeller has replaced the steel impeller on some earlier models. When changing from the steel to the plastic impeller, discard the washer that sits between the spring top and the impeller bottom (**Note:** not all steel impellers are equipped with this washer). Use of the washer is not required with plastic impellers.

It should be possible to easily lift the seal spring from the shaft. This spring is important to the operation of the seal for it maintains the contact between the sealing faces.

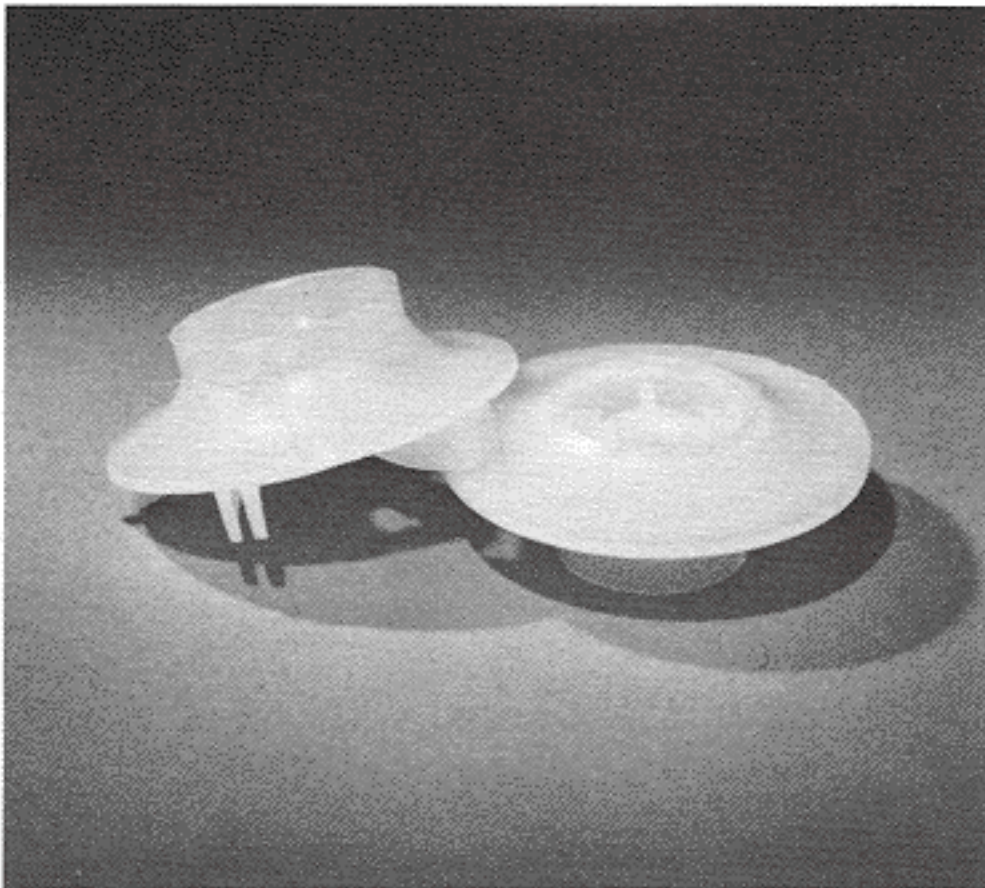

3.5 Removing the Mechanical Seal

The compression ring should fit tightly against the seal collar and it should not be possible to directly lift it from the shaft by hand. Remove the compression ring from the seal collar by inserting a small screwdriver underneath the compression ring and gently applying an upward prying force. Remove the remaining seal parts. It may be necessary to gently pry up on the seal to loosen the seal collar from the shaft.

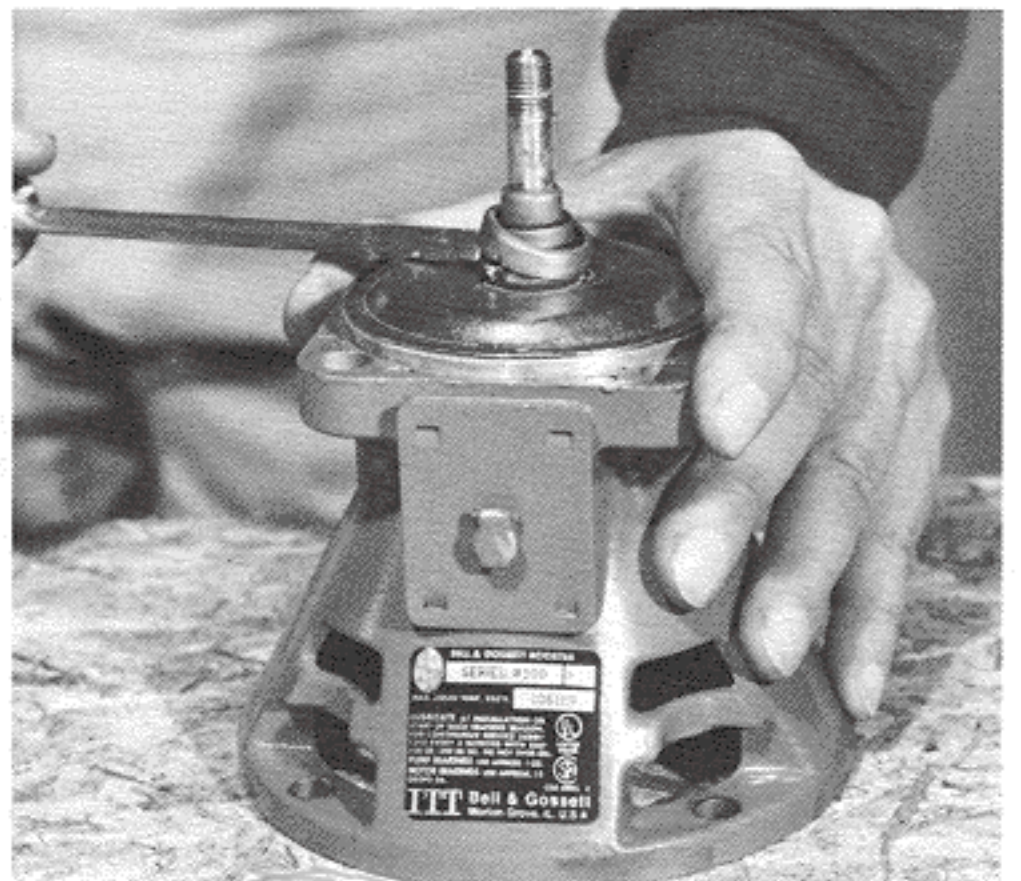

3.6 Removing the Oil Cover

The wicking must be removed before disassembling the bearing assembly. The oil cover retains the wicking and can be removed by placing a screwdriver in the cover's recess and applying a small prying force. Once the cover moves upward about $\frac{1}{2}$ " , it can then be pulled from the bearing bracket.

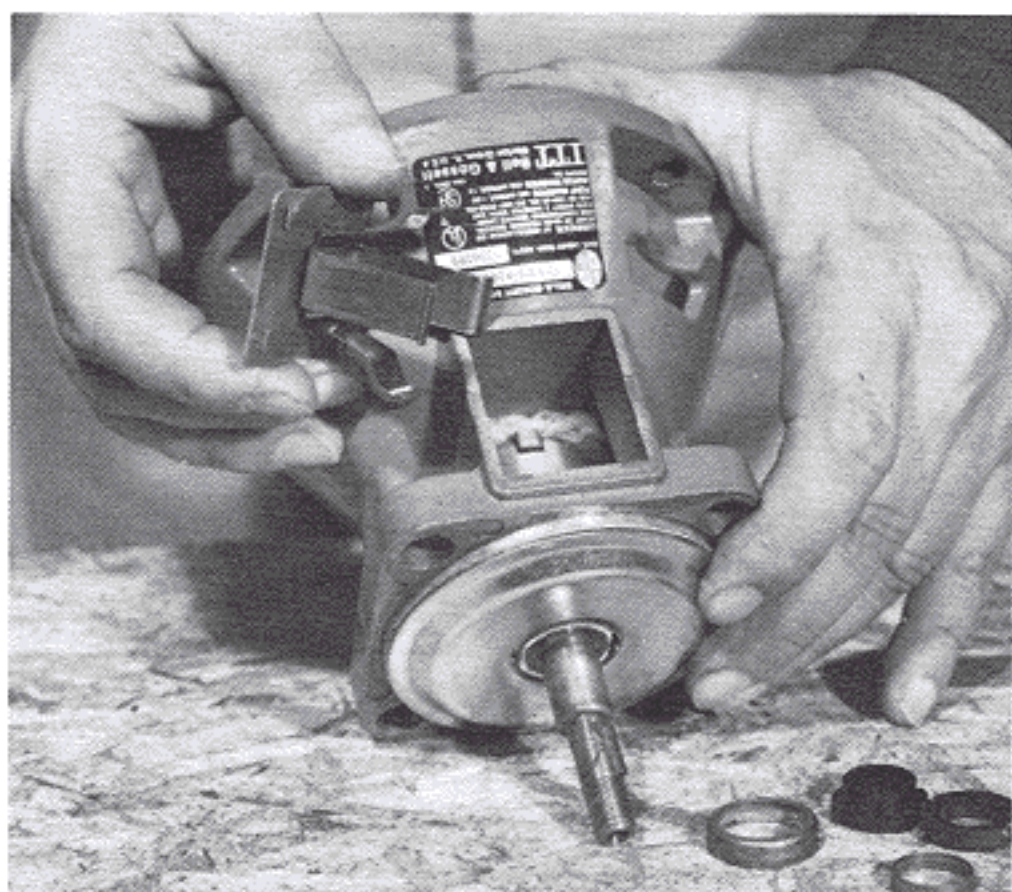

3.7 Removing the Oil Wick

The oil wick* can be removed from the oil reservoir by using a pair of long-nose pliers or screwdriver. Reach into the reservoir with the pliers and grab several strands of the wicking. The entire wick should be freed with a single pull.

If the wick has deteriorated or has become discolored, then it must be replaced. Such deterioration or discoloration is usually the result of charring caused by a lack of oil.

*Boosters other than Series 100 contain two (2) oil wicks.

3.8 Beginning Disassembly of the Front Bearing

Remove the two long screws found in the rear of the assembly. This will unfasten the front bearing from its frame.

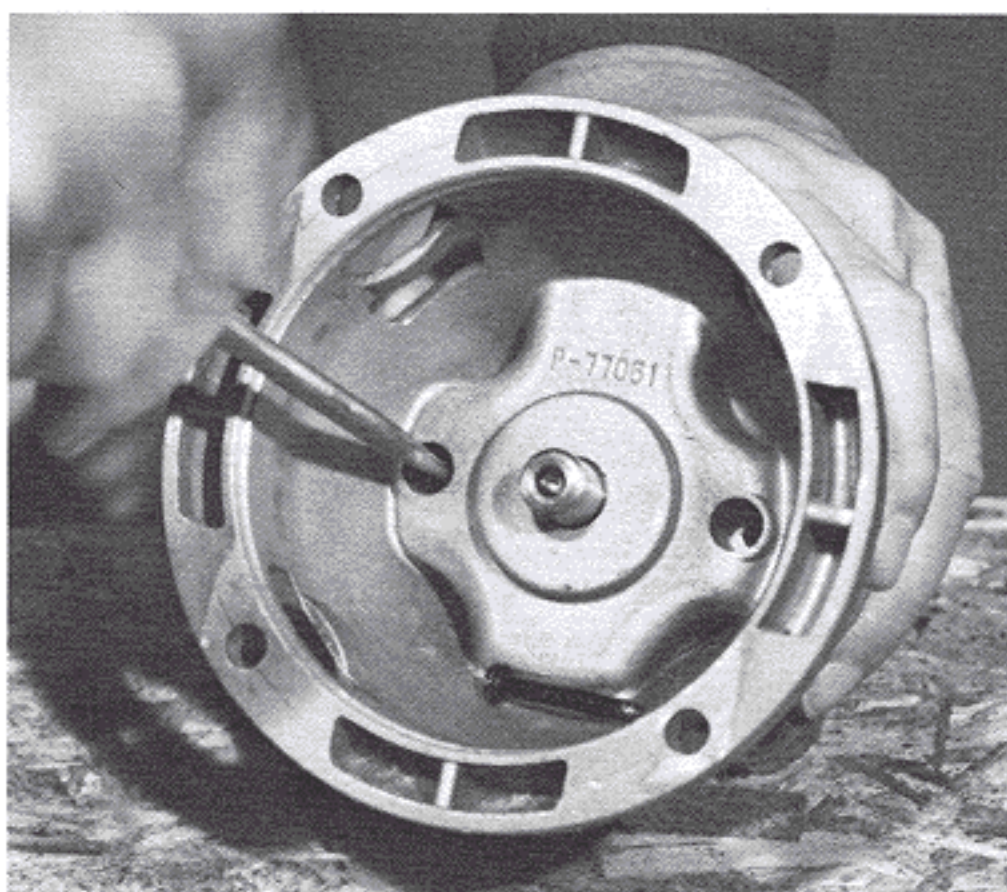

3.9 Removing the Front Bearing

The unfastened front bearing may now be pulled from the bearing assembly. Do not attempt to remove the rear bearing. The rear bearing is permanently pressed into the cast bearing bracket and cannot be replaced. If the rear bearing has failed, replace the entire housing and bearing subassembly.

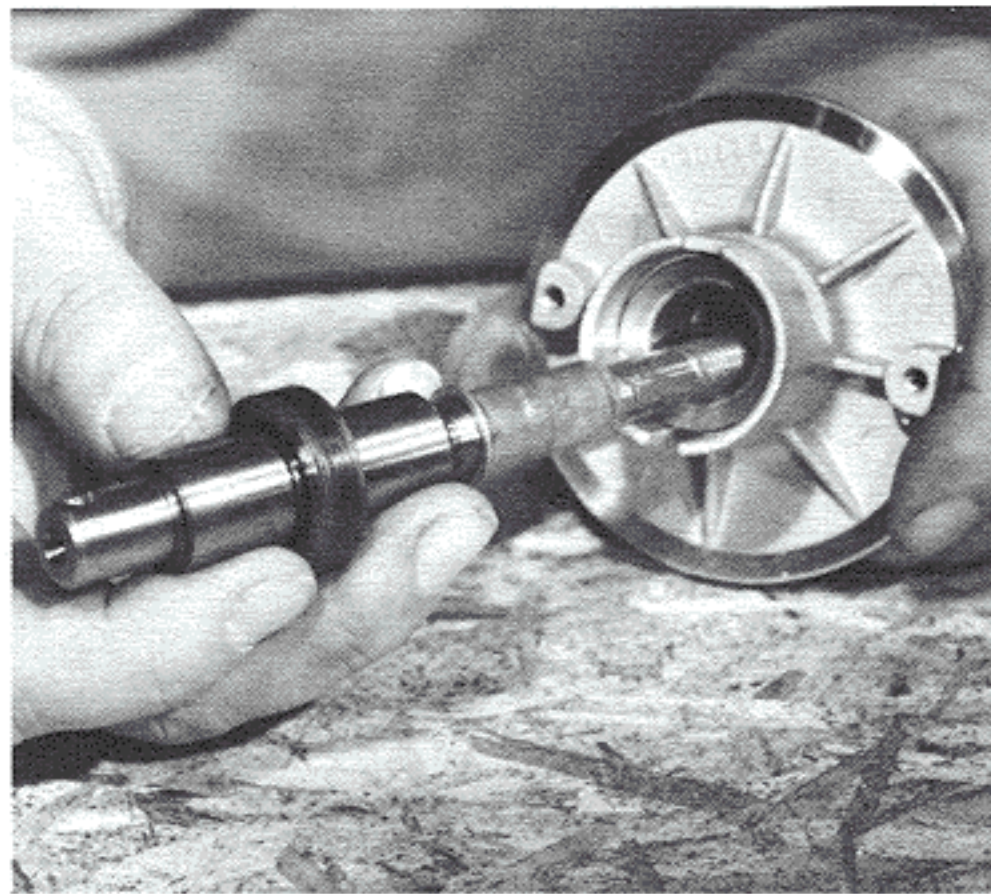
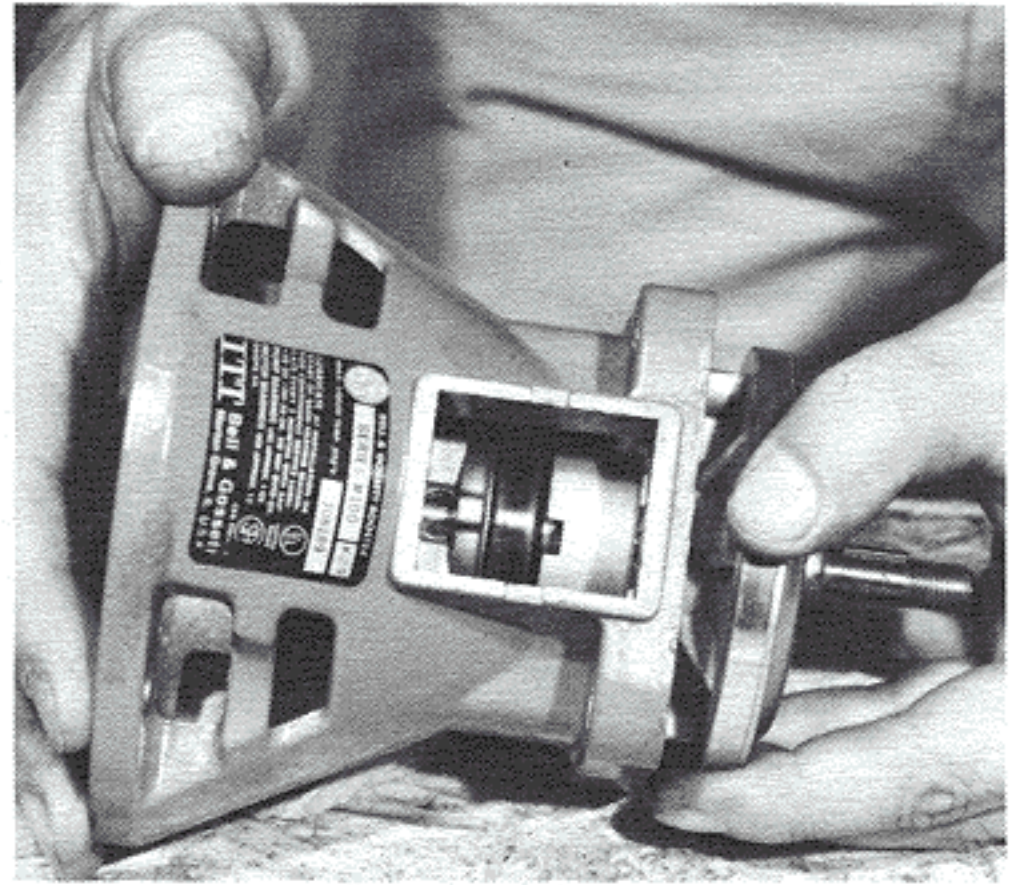

3.10 Examine the Bearing and Pump Shaft

Holding only the front bearing, the pump shaft can now be removed. Inspect the shaft for wear. Use a fine emery cloth to lightly sand the surface of the shaft journals. If the marks along the shaft and bearing surfaces are excessive, the shaft must be replaced.

Examine the front bearing. If there is any evidence of scoring, the bearing must be replaced.

3.11 Cleaning the Shaft's Copper Sleeve

It is not unusual for the copper sleeve to contain deposits of sediment or to show signs of corrosion. Remove the deposits with emery cloth. If corrosion is present in the sealing area, the shaft must be replaced. Do not use the same piece of emery cloth on the shaft journals and sleeve.

Once the needed replacements have been made and the surfaces have been sanded and cleaned, lightly lubricate the shaft and bearing. Slide the shaft back into the front bearing. If the shaft does not enter the bearing as easily as it was removed, check the replacement parts for compatibility.



3.12 Beginning the Reassembly of the Bearing

Ensure that all components have been properly cleaned of debris and other contaminants. Begin by placing a new front bearing gasket in the recess and reseating the front bearing in the assembly. It is very important that the oil slot be directed upward toward the opening of the oil reservoir. To assist in the proper alignment, an indexing lug, found in the bearing assembly, must fit into the recess of the front bearing.

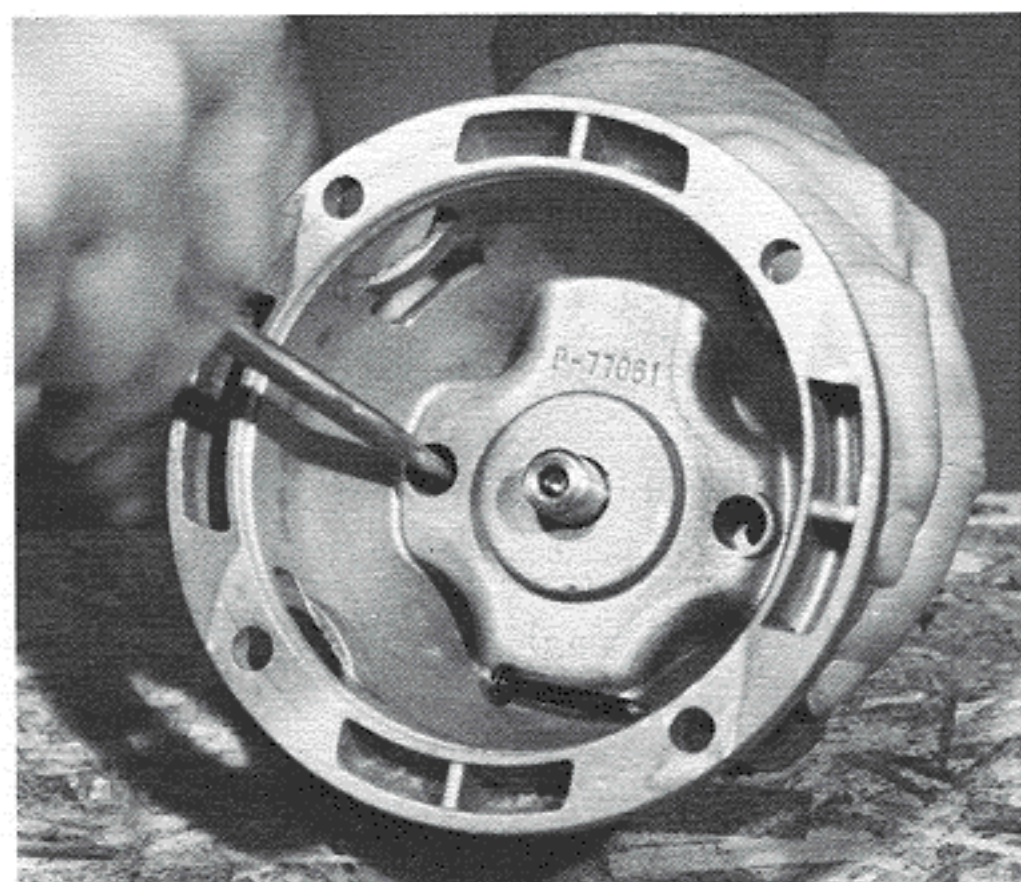
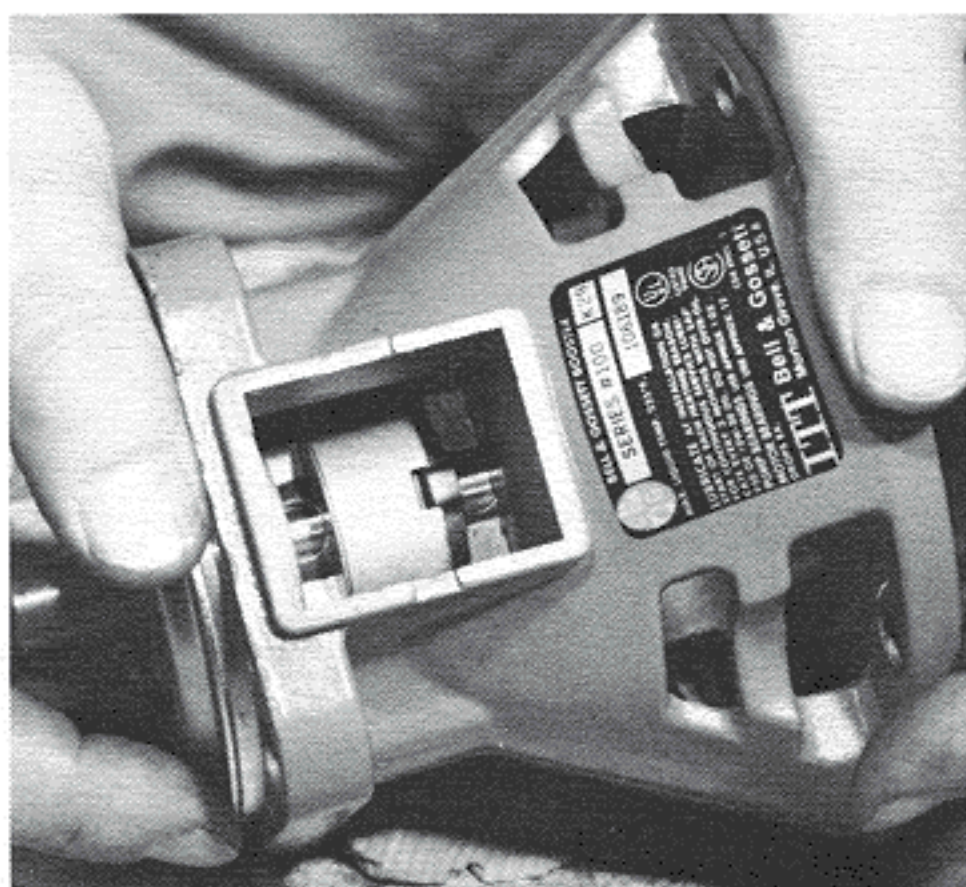
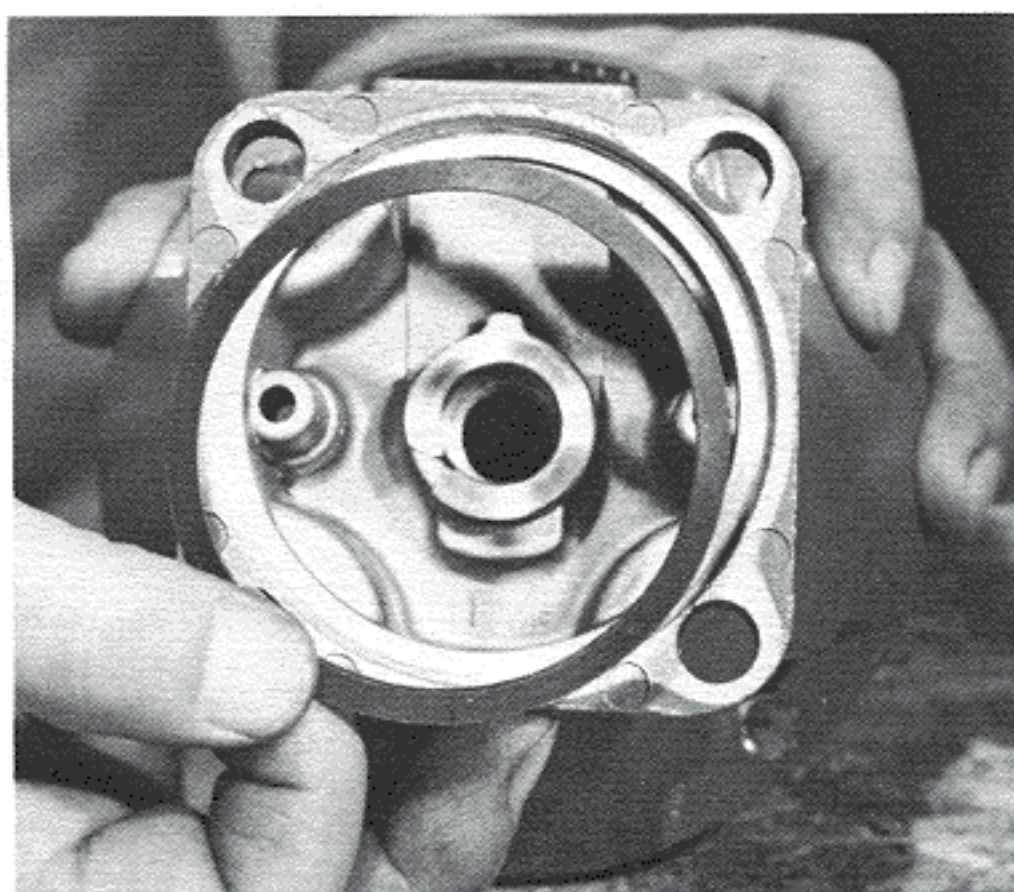

3.13 Securing the Front Bearing

The two long screws removed during disassembly must now be replaced. Take care not to over-tighten the screws. Typically, 15-20 in-lbs of torque will secure the front bearing without over-tightening.

3.14 Installation of the Oil Wick

If a new wick is to be used, it must first be moderately saturated with #20 mineral oil before installing. Moderate saturation of the oil wick will insure lubrication at the beginning of operation.

The wick is properly positioned in the reservoir by placing even lengths of the wick on each side of the bearing. A screwdriver may be used to push the wicking firmly against the bearing. Make certain the wick's ends are lying on the bottom of the reservoir.

Once the wick is in position, the oil cover may be replaced as well.

NOTE: Use only #20 NON-DETERGENT MINERAL OIL.

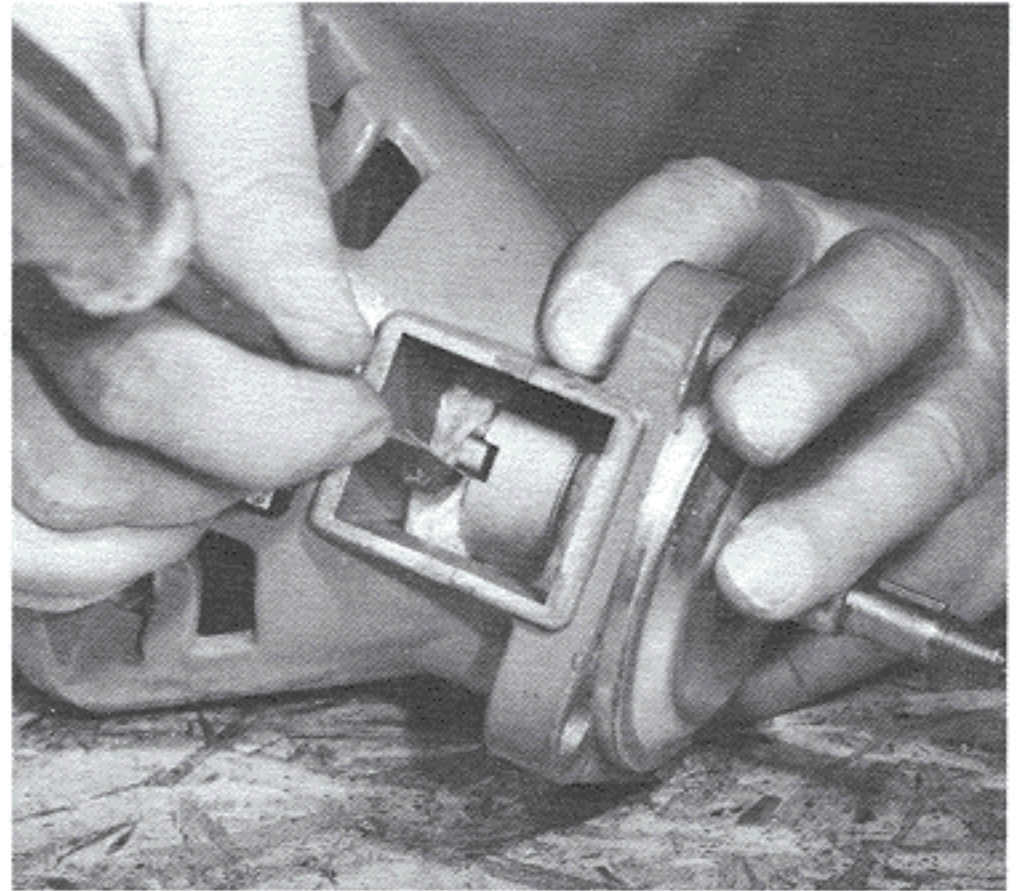

3.15 Replacing the Mechanical Seal

Bell and Gossett seals consist of an insert retainer, rubber gasket, ceramic insert, carbon seal ring, rubber collar, brass collar, and compression ring. Each of these components must be replaced when replacing the mechanical seal.

Each component of the seal except the insert retainer should be easy to remove – simply slide them off the shaft. To remove the retainer, it may be necessary to gently pry it from the assembly.

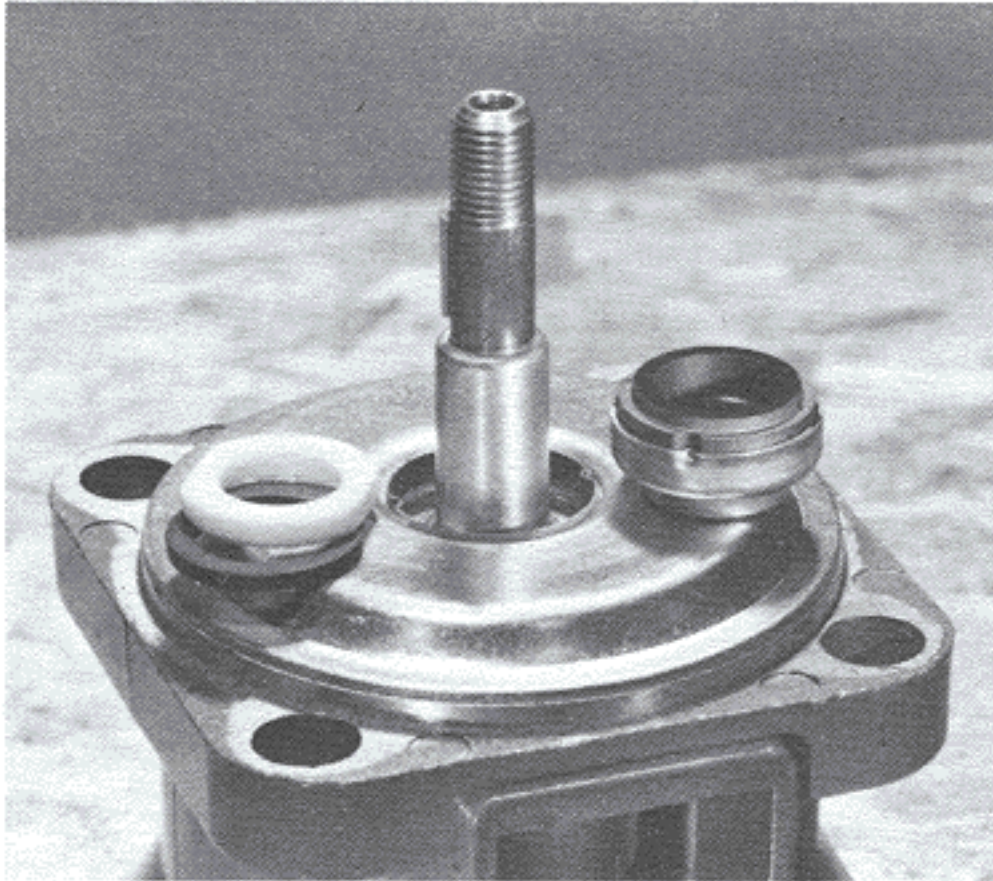

3.16 Clean the Seat of the Mechanical Seal

Using a clean, lint free rag, remove any debris that may have accumulated in the seal recess.

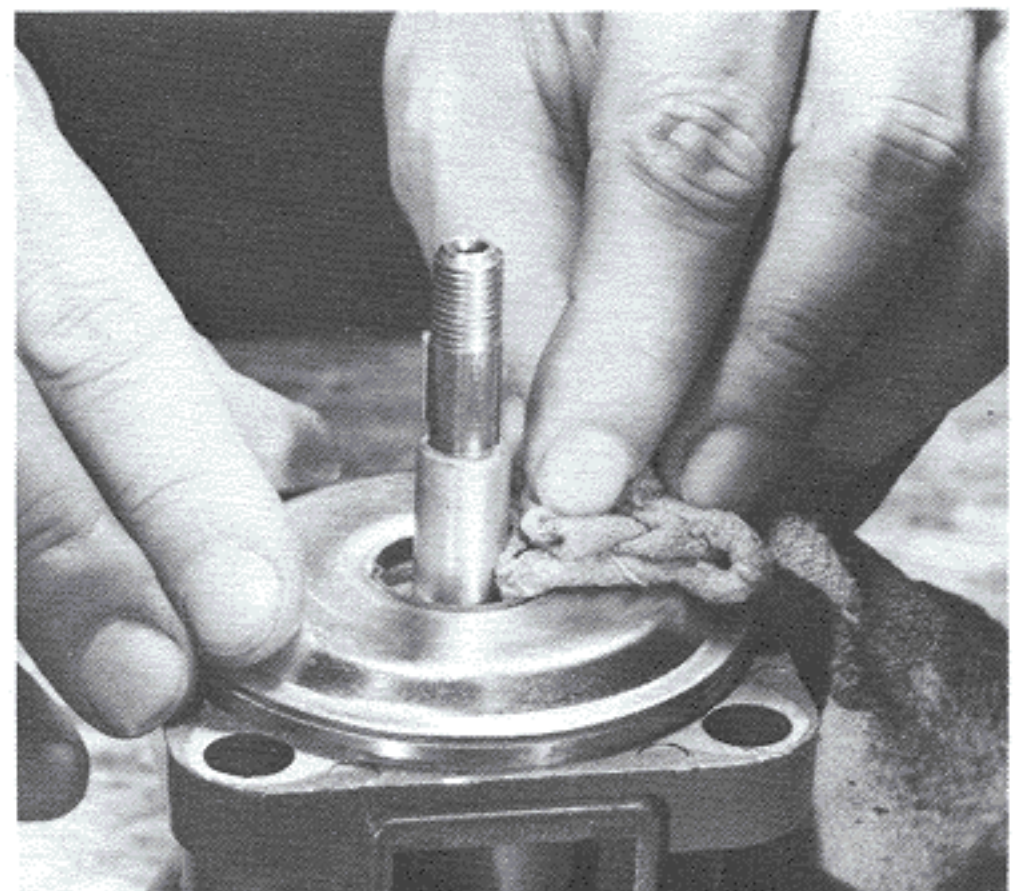

3.17 Installing the Mechanical Seal

Begin the installation by seating the replacement retainer flush against the bearing assembly. Next, place the thin rubber gasket in the recess and set the ceramic insert atop the gasket. Note that the ceramic has a top side and bottom side; the bottom is identified with slightly recessed grooves. These grooves should face downward toward the rubber gasket.

Before proceeding, place the shaft end on a wooden block; the wooden block should push the shaft to its forward-most position (there should not be any end-play in the shaft).

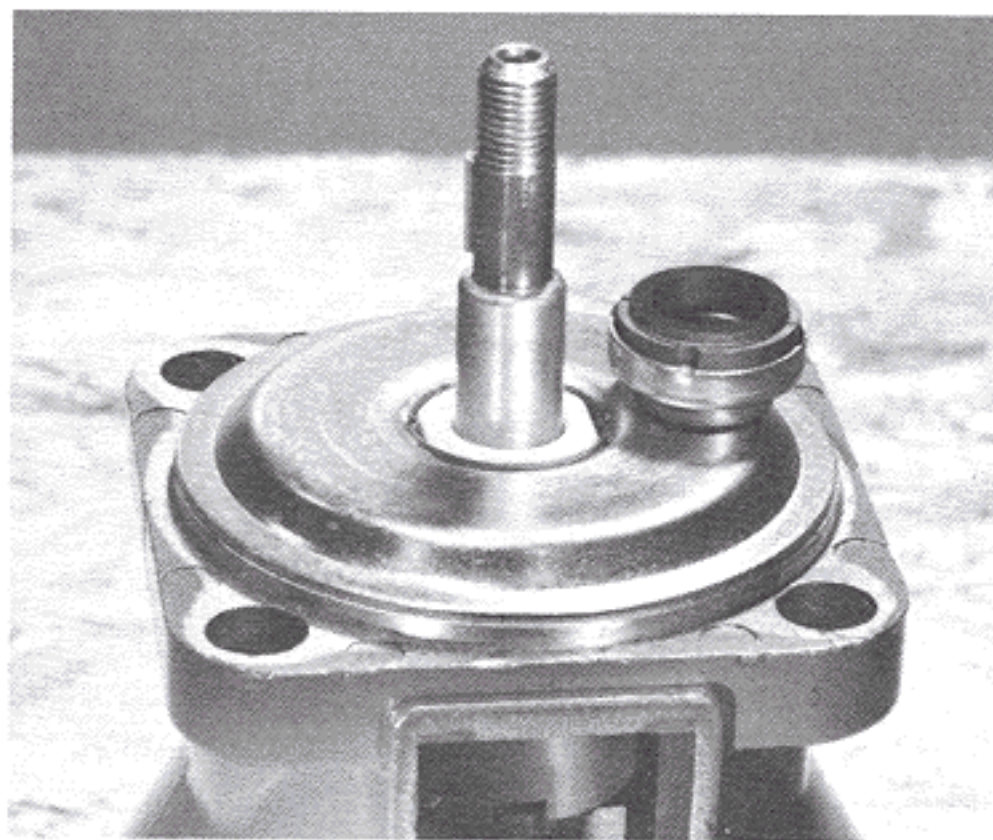

3.18 Final Assembly of the Seal

Lubricate the rubber seal collar with soapy water. The entire rotating seal assembly, which includes the carbon seal ring, rubber collar, brass collar and compression ring, is to be pushed onto the shaft as one unit. Do not attempt to assemble the seal by placing the individual components on the shaft one at a time. The notches in the brass collar should be aligned with recesses found on each side of the carbon insert.

The brass compression ring should now be pressed tightly to the upper end of the rubber collar. A screwdriver can be used at several points along its periphery to provide a fit that is both tight and even. Press with the screwdriver – do not tap. Tapping on the seal may break the ceramic or carbon insert.



3.19 Replacing the Impeller

IMPORTANT: PART COMPATIBILITY NOTE. When changing from the steel to the plastic impeller, discard the washer that sits between the spring top and the impeller bottom. Use of the washer is not required with plastic impellers. Failure to eliminate the washer could result in faulty operation.

With the shaft still resting on the wooden block, place the seal spring on the shaft; it should rest atop the brass collar. Next, place the impeller (see note above – there should be no washer) and if required, the lock washer on the shaft (this lock washer is not used with the plastic impeller either). Thread the impeller nut to the shaft and tighten with a socket wrench or an offset box wrench.

DO NOT OVER-TIGHTEN – provide 25-45 in-lbs of torque to secure the plastic impeller. For Boosters and Series 60/90/1522/1535 pumps



with metallic impellers, provide 96-144 in-lbs of torque.

4.0 REASSEMBLY OF THE SYSTEM PUMP

Bell & Gossett Booster Pumps operate best when accurately aligned and securely affixed to the system. Noise, vibration, and efficiency are operational parameters that may be adversely affected by the reassembly of the pump. It is therefore very important that the following steps be carefully followed to ensure dependable performance.

4.1 Inspect and Clean the Pump Body

The pump body must be cleaned. Excess debris from water scale, worn gaskets or any other material found in the pump body must be removed. A screwdriver may be used to scrape any material stuck to the body.

The seating surface of the new gasket must be free of all foreign material to insure proper seating and leak prevention.

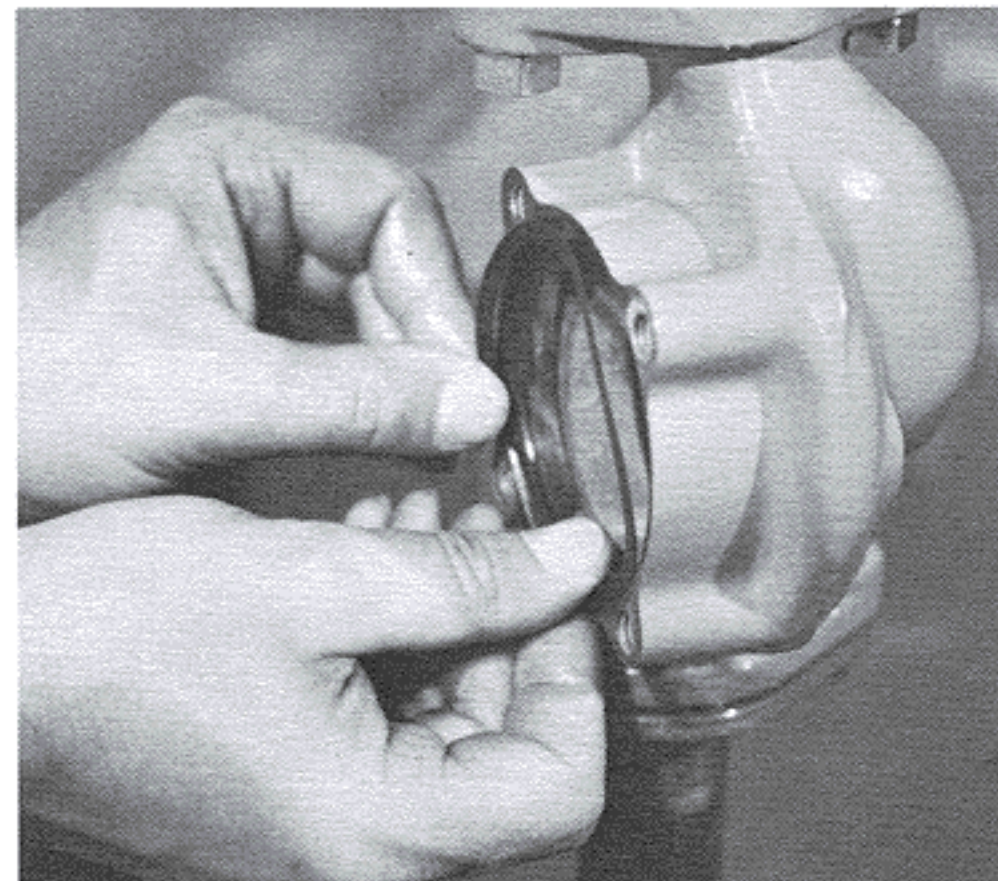
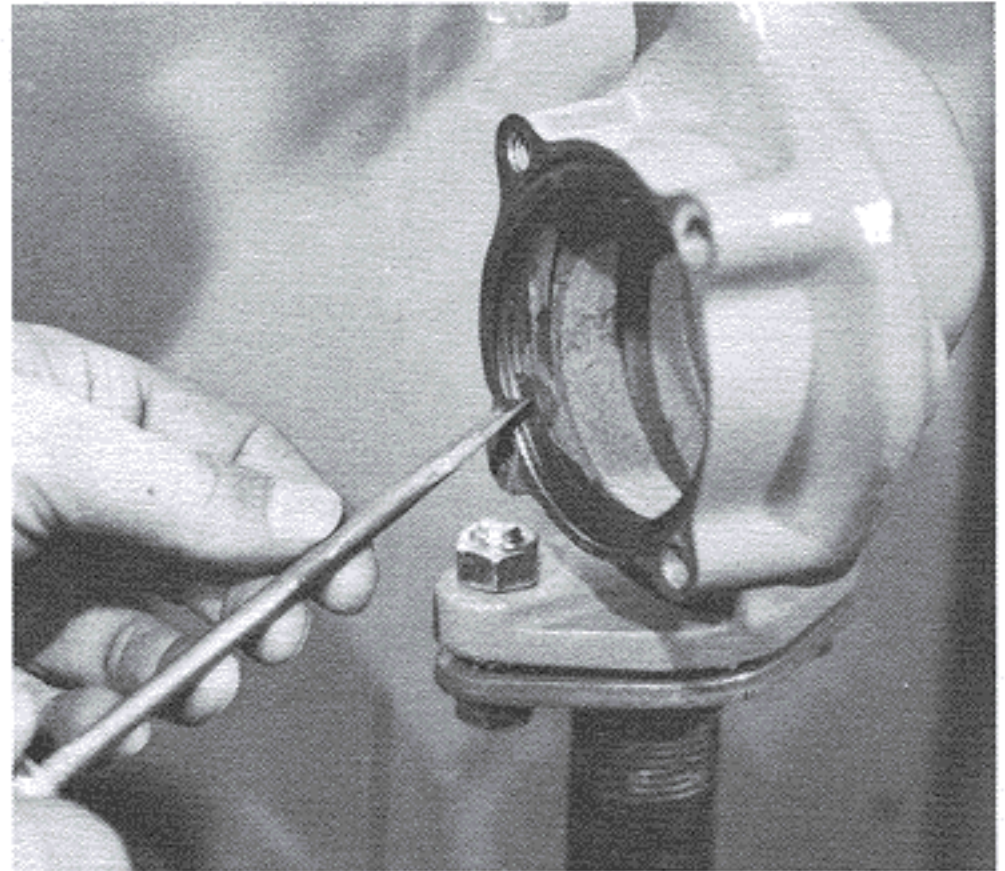

4.2 Installing a New Pump Body Gasket



WARNING: Hot Water Hazard

Whenever the bearing assembly is removed from the pump body, use a new gasket when re-installing. Failure to follow these instructions could result in serious personal injury and/or property damage.

Place the new gasket in the recess of the pump body. Turn the gasket slightly in each direction to insure that it is sitting flush against the gasket surface without obstruction from debris. Several drops of oil or anti-freeze compound can be used on the back side of the gasket to hold it in place during reassembly.

4.3 Aligning the Bearing Assembly

Replace the bearing assembly by inserting the impeller in the pump body. The mounting holes and tappings should be aligned so that the oil fill cap faces upward.

Evenly tighten the four bolts. If there is difficulty in seating the bearing assembly, remove it, turn the impeller slightly in either direction and make another attempt.

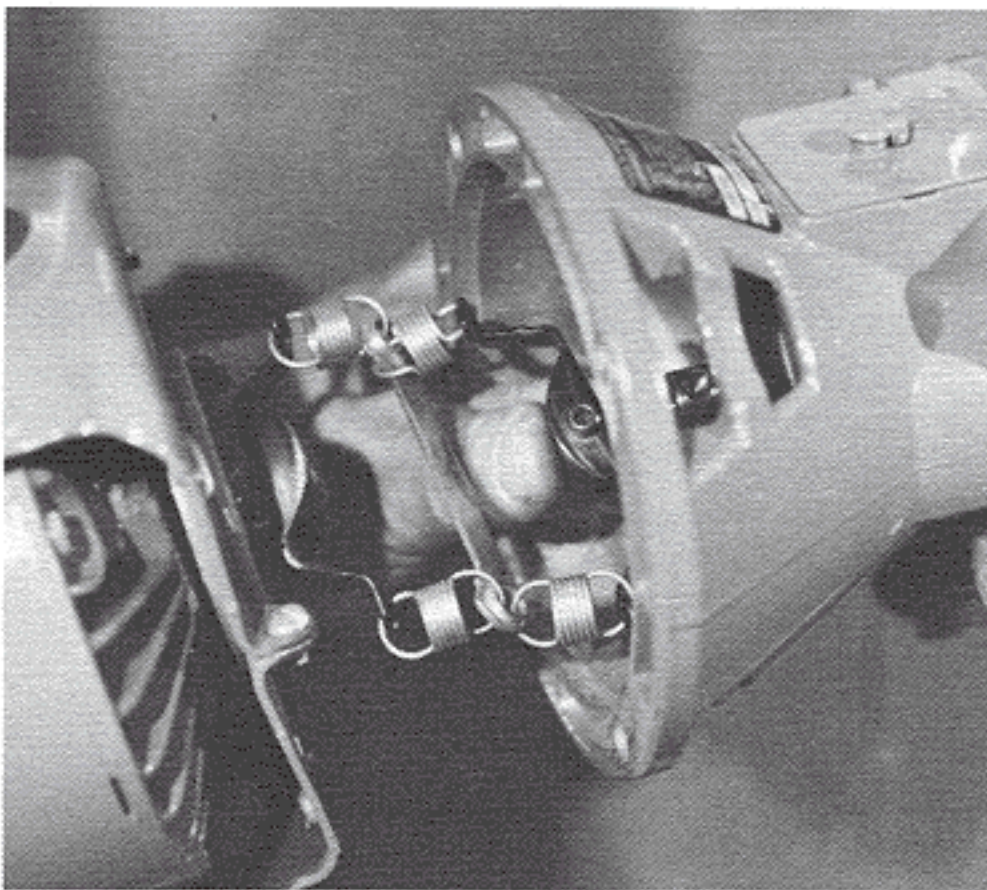
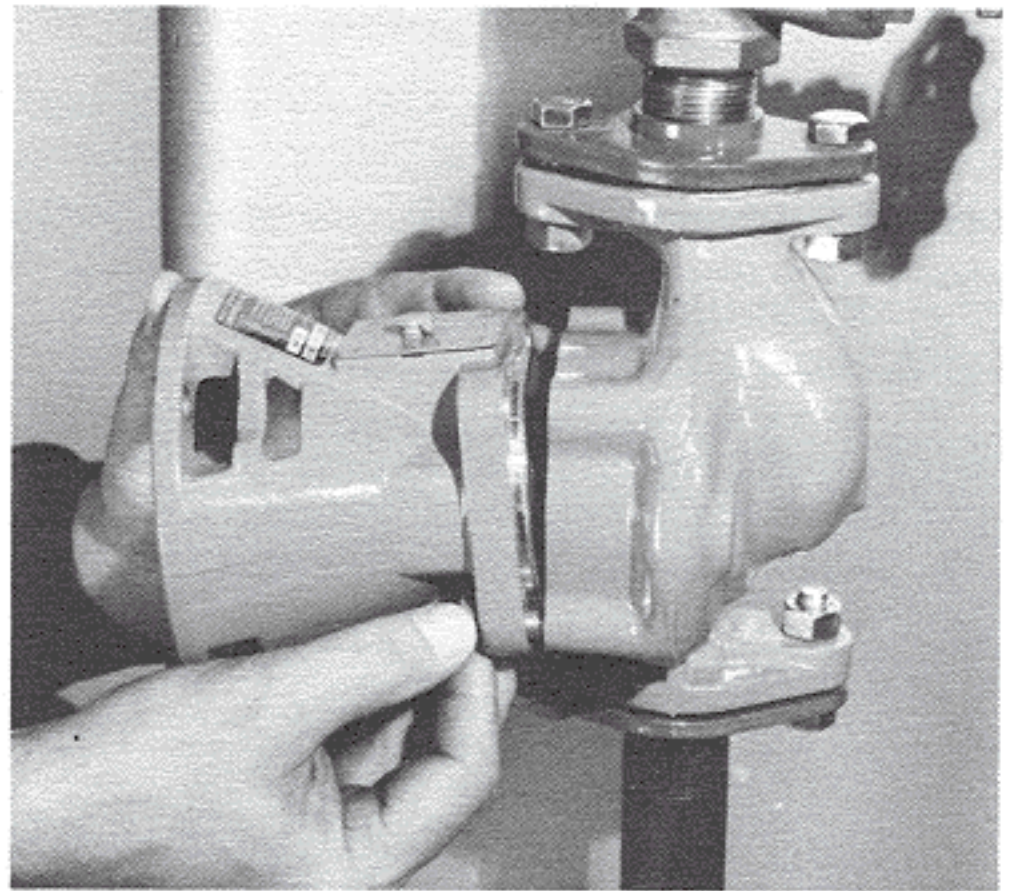

4.4 Attaching the Coupler

The easiest way to attach the bearing assembly to the motor is to hold the motor with one hand and using the thumb of the other to push the bore of the coupler onto the pump shaft. This should be done such that the coupler set screw is directly above the recess in the pump shaft. Use an Allen wrench to tighten the set screw; it should seat in the shaft recess.

4.5 Installing the Motor

Check to insure that the plastic oil tubes of the motor face upward. Replace the four cap screws that are placed through the bearing assembly and into the motor mounting bracket. Evenly tighten each cap screw.

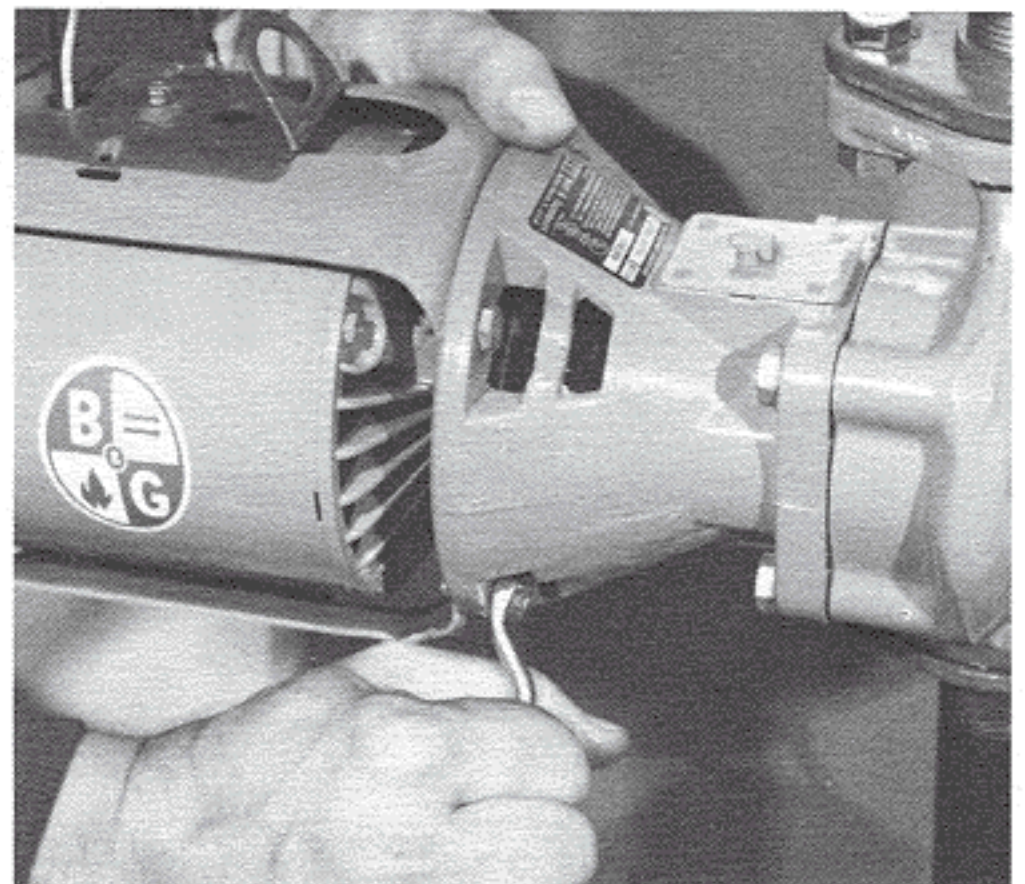

5.0 RESTARTING THE SYSTEM

Once the pump body, bearing assembly, and motor have been installed, a number of steps must be taken to make the system operational. Follow these instructions carefully in order to reduce the risk of system failure and/or personal injury.

WARNING: Hot Water Leakage Hazard Whenever the pump has been removed from the piping, use new flange gaskets when re-installing. Failure to follow these instructions could result in serious personal injury and/or property damage.

WARNING: Hot Water Leakage Hazard To prevent leakage, make certain that the flange bolts have been adequately torqued. Failure to follow these instructions could result in serious personal injury and/or property damage.

5.1 Filling and Venting the System

Open the pump suction and discharge valves. If the system was drained, it will be necessary to close the boiler drain valve and then open the shut off valve before the reducing valve to supply water to the boiler.

Eliminate air introduced into the system by venting it from a high point in the system or by an alternate method.

WARNING: High Pressure Hazard Pressurize the pump body slowly. Hot water leaks can occur. Check for leaks at all joints with gaskets. Failure to follow these instructions could result in severe personal injury and/or property damage.

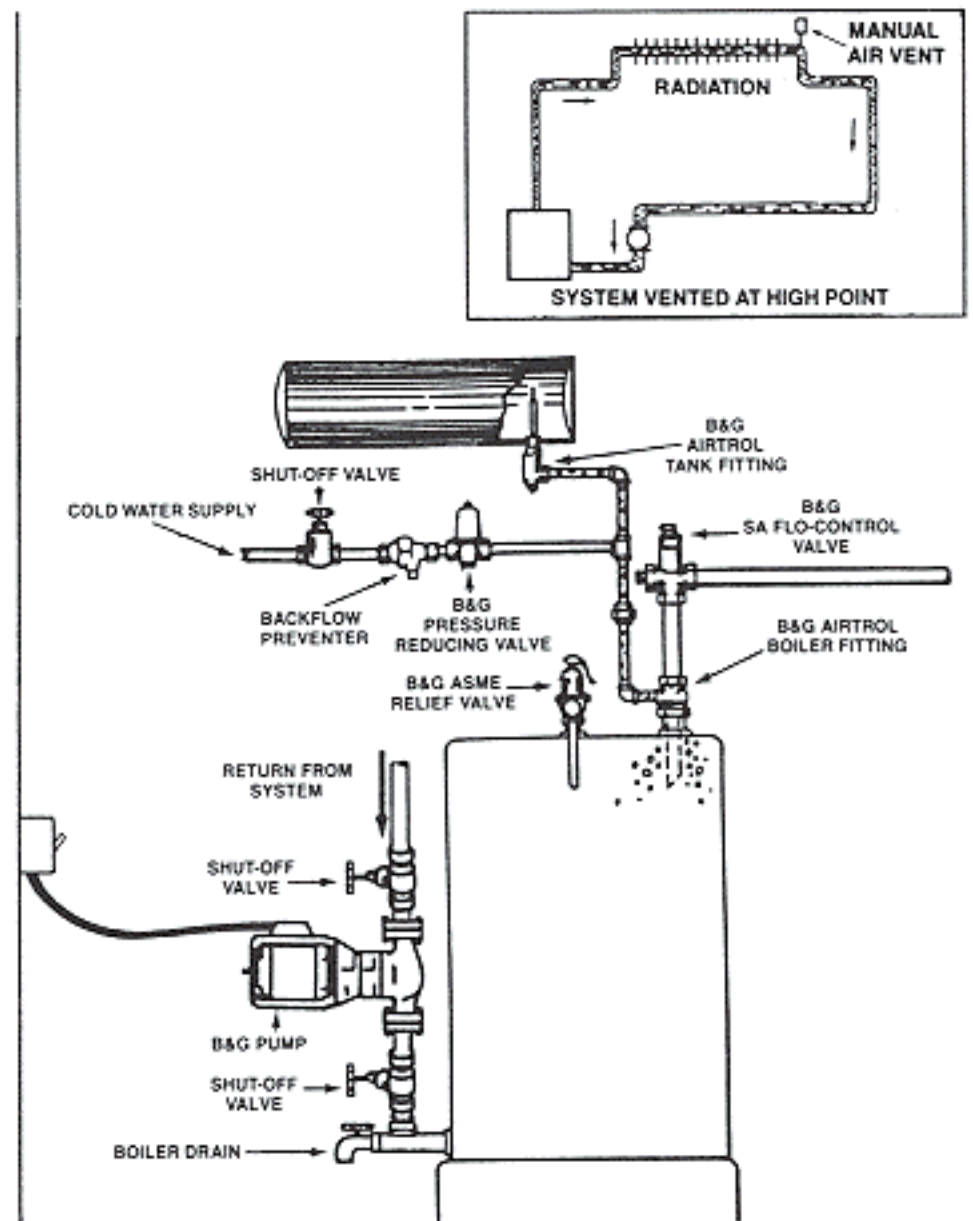

5.2 Connecting the Electrical Power

WARNING: Electrical Shock Hazard Be certain that all connections are secure and the conduit box cover is closed before electrical power is re-connected. Failure to follow these instructions could result in serious personal injury and/or death.

Connect the electrical power to the boiler, pump and any related accessories. Return the system to normal operating condition. Check the pump and the surrounding piping for evidence of leaking and correct as required.

After a short period of operation, additional air should be vented from the system through a vent located at a high point in the system.

6.0 SPECIAL CONSIDERATIONS

Bell & Gossett recommends that the following steps be taken to ensure the best performance from your booster pumps.

6.1 Proper Oiling Procedures

Most misalignment problems can be attributed to motor mounts that begin to sag. Such sagging will lead to coupler fatigue and ultimately to failure. The life of motor mounts can be significantly increased if proper oiling procedures are followed. When motors receive excessive oil, the spill-over can saturate and soften the mount's neoprene material; over oiling can also cause spillage onto surrounding surfaces.

Bell & Gossett recommends that the pump bearings be lubricated with $\frac{1}{2}$ teaspoon (20 to 30 drops) of B&G 20# weight non-detergent oil at the start of each heating season. A SAE 20 oil or 10W-30 oil may be substituted if B&G oil is not available.

Motor bearings should be lubricated as instructed on the lubrication decal once every four months (more often under adverse conditions). Use eight to ten drops in each oil tube.

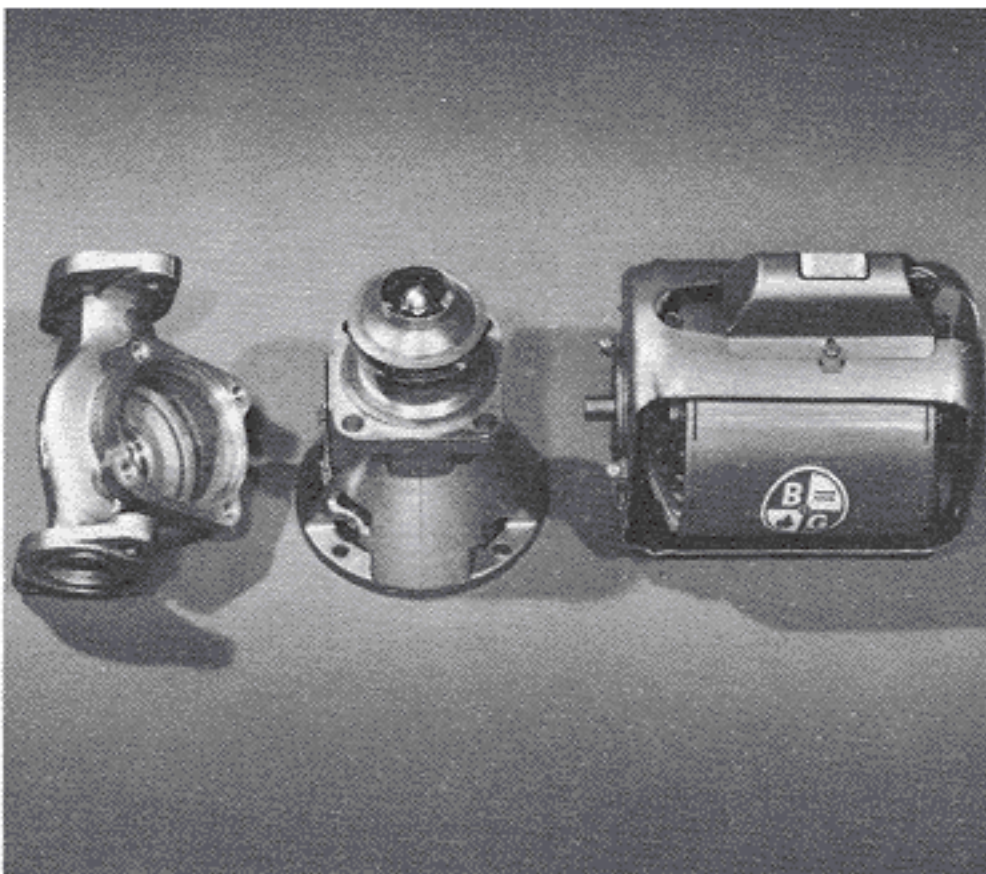
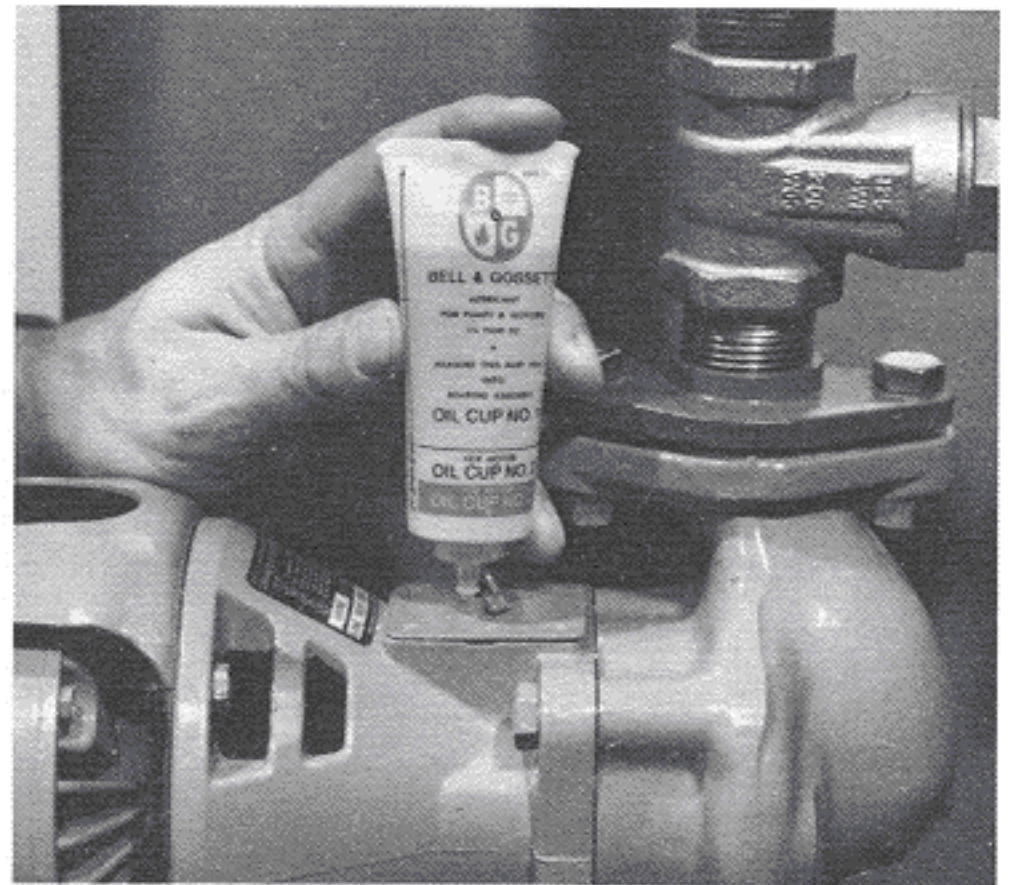

6.2 Bronze Body Boosters

The bearing assembly of the bronze booster pump is similar to that of the iron booster pump. Except for the front bearing, all parts are interchangeable.

The bronze booster has a brass face plate, impeller, and acorn nut. All other parts are interchangeable.

PUMPING SYSTEM TROUBLE ANALYSIS GUIDE

COMPLAINT	POSSIBLE CAUSE	RECOMMENDED ACTION
No circulation	Set screw not tight, coupler loose on shaft Impeller slipping on shaft Air-bound system Air-bound pump Broken pump coupler Clogged impeller or piping System valve closed Pump electrical circuit broken	Tighten set screw in recess in the shaft Check to see if impeller is placed on the key way of the shaft Tighten impeller nut Vent system Vent pump casing Replace; check alignment Locate and remove obstruction Open Check all related low and line voltage circuits
Inadequate circulation	Air-bound system Air-bound pump Clogged impeller or piping Clogged strainer Pump impeller damaged Insufficient NPSH (Net Positive Suction Head) Pump too small Partially air-bound pump Pump running backwards (three phase) Improper motor speed	Vent system Vent pump casing Locate and remove obstruction Remove and clean screen Replace Lower pump or raise pressure or relocate Replace pump or impeller Vent pump casing Reverse any two motor leads Check wiring and voltage

COMPLAINT	POSSIBLE CAUSE	RECOMMENDED ACTION
Pump or system noise	Entrained air Pump cavitation Pump misalignment Worn pump coupler Excessive water velocity Poor foundation (base-mounted) Pipe vibration	Vent system Lower pump or raise pressure or relocate (See note) Re-align pump Replace; check alignment Install balancing cocks or parallel piping Provide rigid foundation with adequate grouting Provide adequate pipe support
Premature failure of pump components	Improper pump (size) (type) Improper pump location Pump misalignment Excessive water treatment Over-oiling of pump Under-oiling of pump Pump operating close to or beyond end point of curve Excessive piping load	Replace Relocate Re-align Check manufacturer's instructions Check manufacturer's instructions Check manufacturer's instructions Balance system Provide proper pipe support
Seal failures within 1 year period or less in a closed system	Excessive dirt, sand and oxides Excessive or improper water treatment Pump Cavitation: 1. Improper selection 2. Compression tank location Air-seal without lubricant (water) Excessive temperatures Pumps run without fluid	Clean system Check for proper water treatment recommendations from pump manufacturer Check pump operation on its curve — overloading High head pump must have compression tank on suction side of pump Vent air from pump volute Check type of seal and maximum operating temperature from manufacturer Pumps must be primed before operation
Seal pitting – Oxygen corrosion – Magnetic iron oxide	Caused by wear and excessive amounts of free oxygen	Check if system has a constant leak Fresh water feeding carries oxygen into the system

NOTE: Cavitation can be recognized by low rumbling or sharp rattling noises. The situation is created by the lack of available net positive suction head (NPSH). The pressure at some point in the pump falls below the vapor pressure of the water, causing flashing and the formation of bubbles, which are carried into the volute where the higher pressure causes them to implode. This can eventually destroy the pump.

Ensure Quality and Performance with...

B&G FACTORY GUARANTEED REPLACEMENT PARTS



Bell & Gossett has an extensive international network of over 1,000 product wholesalers to provide access to genuine B&G replacement parts. In addition to the wholesalers, there are over 350 authorized motor repair stations if repair to the motor's interior ever becomes necessary.

Although this manual deals specifically with the Bell & Gossett Series 100 Pump, these service procedures can be applied in general to all the pumps in the Bell & Gossett Booster Pump line.

For further information, contact ITT Bell & Gossett, 8200 N. Austin Avenue, Morton Grove, IL 60053,
Phone: (847) 966-3700 — Facsimile (847) 966-9052.

