

RING COMPRESSORS & VACUUM PUMPS



FUJI ELECTRIC
CATALOG





TABLE OF CONTENTS

▶ RING COMPRESSORS

VFC06	.3
VFC08	.5
VFC10	.7
VFC20	.9
VFC30	.11
VFC40	.13
VFC50	.15
VFC60	.17
VFC70	.19
VFC80	.21
VFC90	.23

▶ ACCESSORIES

Aspirators	.25
Exhaust Silencers	.27
High Volume Filter / Receivers	.28
Inline Filter / Traps	.29
Inlet Filters / Receivers	.32
Inline Vacuum Filters	.33
Pressure Relief Valves	.34
Vacuum Boosters	.35
Vacuum Receiver	.36
Vacuum Relief Valves	.37

▶ APPLICATIONS

Air Knife	.38
Design Considerations	.39
Electrical	.41
Spas and Hot Tubs	.43
Tank Agitation	.45



VFC06

RING COMPRESSOR



The VFC06 is a single-stage ring compressor with a maximum pressure of 10 in. H₂O, a maximum vacuum of 9.7 in. H₂O and a maximum capacity of 17.7 SCFM. It comes complete with a direct drive, 1/20 horsepower, TENV motor capable of operating on 115 volts, on 50 or 60 Hz. A built-in automatic reset thermal protector is standard. This version has NEMA class B insulation, is UL recognized, CSA certified, and CE.

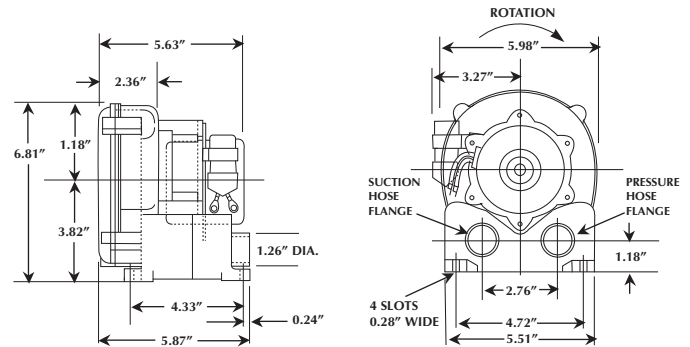

SPECIFICATIONS

Model No.	Hz	Voltage		Amps (Max. Rated)	Amps (Locked Rotor)	Max. Pressure	Max. Vacuum	Max. Airflow	Min. Airflow	Max. Temp Rise (ΔT)	Weight
		Low Voltage	High Voltage			in. H ₂ O	in. H ₂ O	SCFM	SCFM	°F(°C)	lbs.(kg)
VFC063P-1T	60	115		0.56	1.2	10	9.7	17.7	0	54(30)	6.0(2.7)
	50	110		0.4	0.9	7.5	7.3	14.7	0	36(20)	

ACCESSORIES

Description	Vacuum Relief Valve	Pressure Relief Valve	Inlet Filter	Inlet Filter Cover	Exhaust Silencer/Muffler
Model No.	Not Req'd	Not Req'd	F-123	C-123	VFY-021A

NOTE: Maximum allowable time at deadhead is unlimited.



VFC06 PERFORMANCE DATA

KEY

- 60 Hz
- 50 Hz

PRESSURE

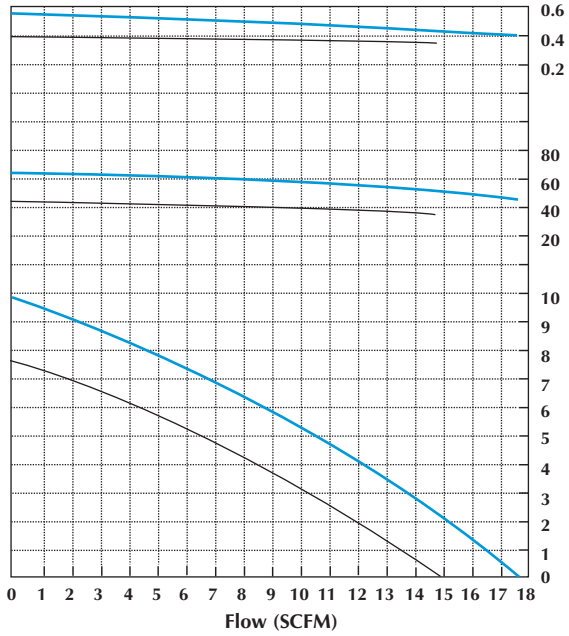

VACUUM

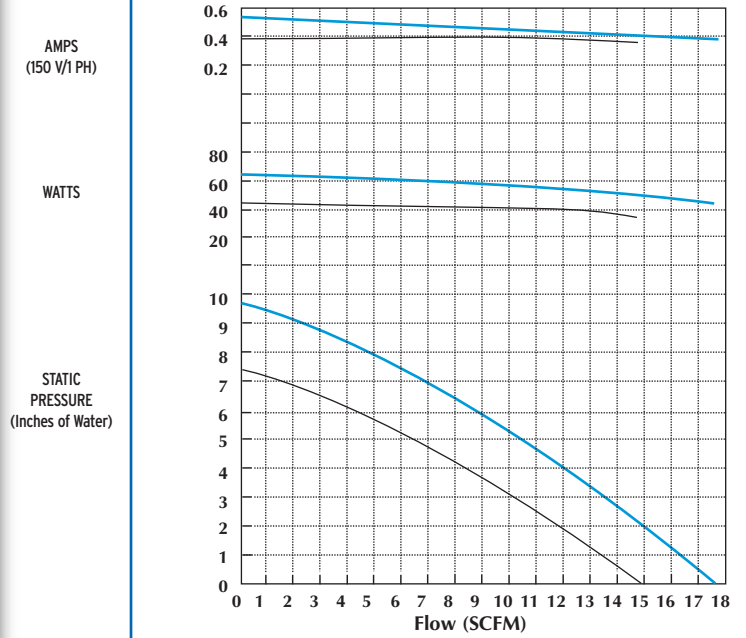

TEMPERATURE RISE

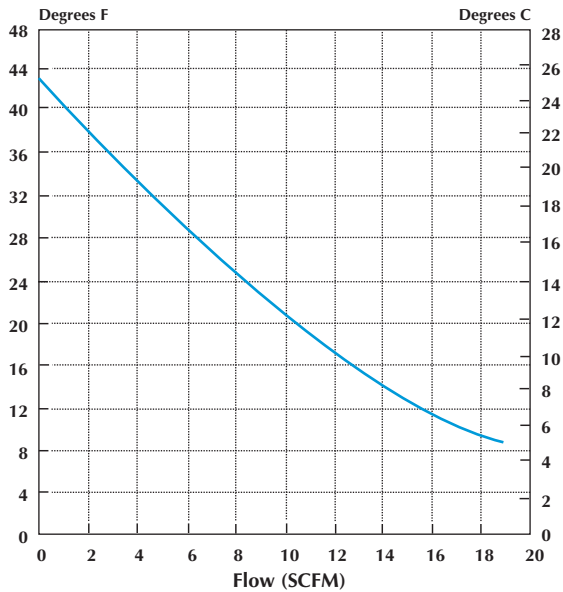

SOUND LEVEL

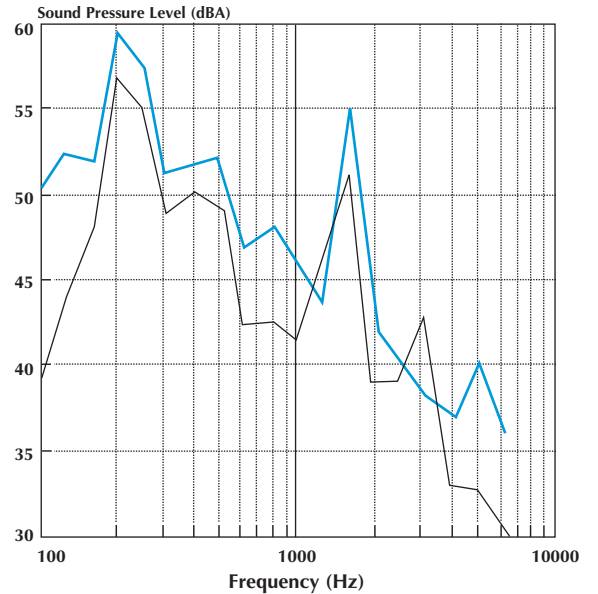

*Measured at distance of 1.0 meters



The VFC08 is a single-stage ring compressor with a maximum pressure of 19.5 in. H₂O, a maximum vacuum of 18.7 in. H₂O, and a maximum capacity of 19.5 SCFM. It comes complete with a direct-drive, 1/10 horsepower, TEFC motor capable of operating on a wide range of voltages and on 50 or 60 Hz. A pilot-duty thermal protector is standard equipment on all 3-phase models, and built-in automatic reset thermal protectors on 1-phase units. All versions have NEMA class B insulation, are UL recognized, CSA certified and CE.

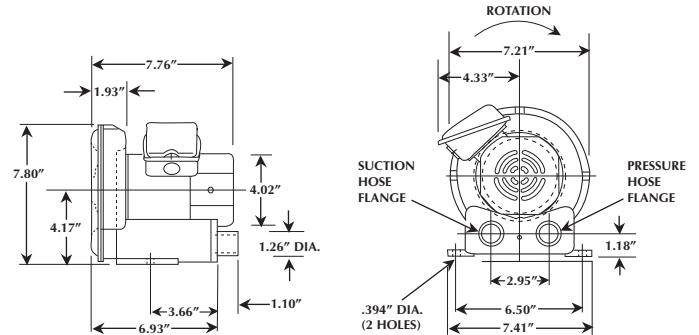

SPECIFICATIONS

Model No.		Hz	Voltage	Amps (Max. Rated)	Amps (Locked Rotor)	Max. Pressure in. H ₂ O	Max. Vacuum in. H ₂ O	Max. Airflow SCFM	Min. Airflow SCFM	Max. Temp Rise (ΔT) °F(°C)	Weight lbs.(kg)
			Low Voltage/High Voltage								
1 Phase	VFC084P-5T	60	115/230	1.2/0.6	3.4/1.7	19.5	18.7	19.5	0	54(30)	13.3(6.0)
		50	110/220	1.1/0.5	3.2/1.6	15	14.4	16.5	0	36(20)	
3 Phase	VFC084A-2T	60	200-240	0.42-0.40	1.8-2.1	19.5	18.7	19.5	0	54(30)	
		50	190-230	0.37-0.32	1.8-2.1	15	14.4	16.5	0	36(20)	
	VFC084A-4W	60	400-480	0.21-0.20	0.9-1.1	19.5	18.7	19.5	0	54(30)	
		50	380-460	0.18-0.16	0.9-1.1	15	14.4	16.5	0	36(20)	

ACCESSORIES

Description	Vacuum Relief Valve	Pressure Relief Valve	Inlet Filter	Inlet Filter Cover	Inlet Filter/Receiver	Exhaust Silencer/Muffler
Model No.	Not Req'd	Not Req'd	F-123	C-123	R15P1.5	VFY-021A



NOTE: Maximum allowable time at deadhead is unlimited

VFC08 PERFORMANCE DATA

KEY

- 60 Hz
- 50 Hz

PRESSURE

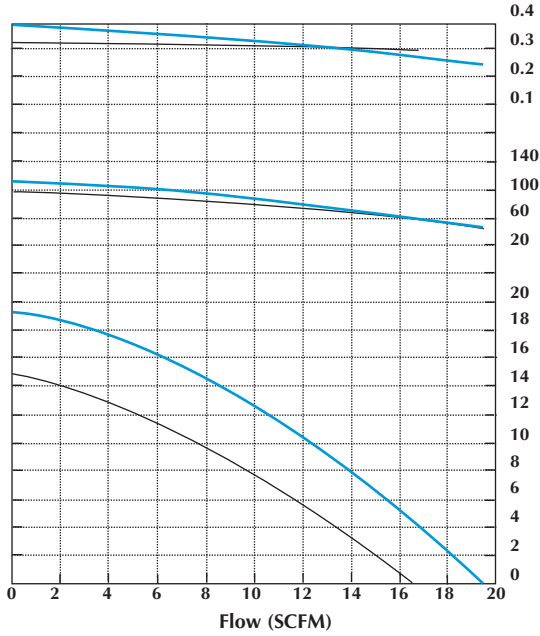

VACUUM

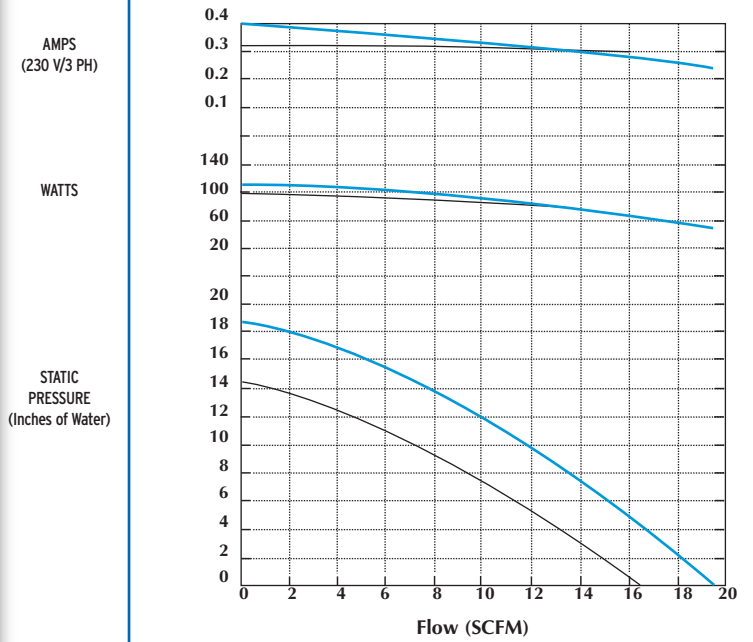

TEMPERATURE RISE

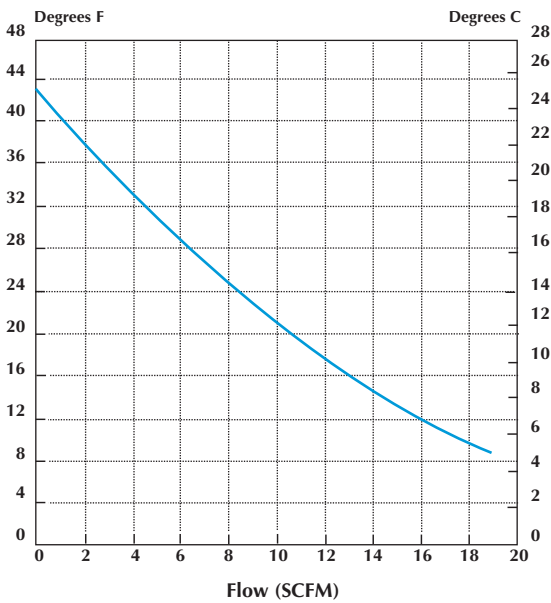

SOUND LEVEL

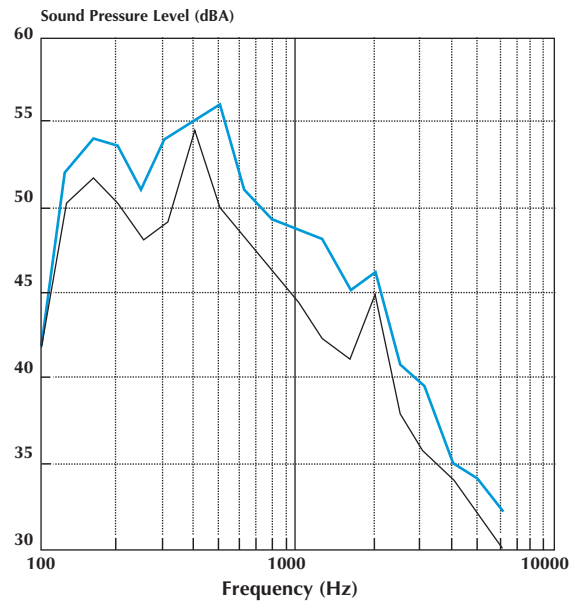

*Measured at distance of 1.0 meters



The VFC10 is a single-stage ring compressor with a maximum pressure of 27.5 in. H₂O, a maximum vacuum of 26 in. H₂O, and a maximum capacity of 27 SCFM. It comes complete with a direct-drive, 1/6 horsepower, TENV motor capable of operating on a wide range of voltages, and on 50 or 60 Hz. A pilot-duty thermal protector is standard equipment on all 3-phase models, and built-in automatic reset thermal protectors on 1-phase units. All versions have NEMA class B insulation, are UL recognized, CSA certified and CE.

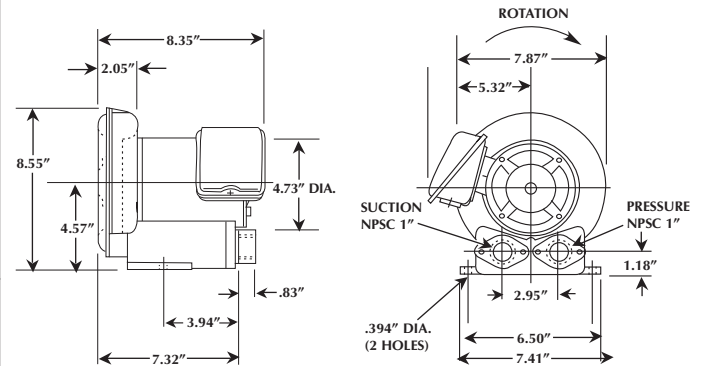

SPECIFICATIONS

Model No.	Hz	Voltage		Amps (Max. Rated)	Amps (Locked Rotor)	Max. Pressure	Max. Vacuum	Max. Airflow	Min. Airflow	Max. Temp Rise (ΔT)	Weight
		Low Voltage/High Voltage		in. H ₂ O	in. H ₂ O	SCFM	SCFM	°F(°C)	lbs.(kg)		
3 Phase 1 Phase VFC100P-5T	60	115/230	1.5/0.75	8.4/4.2	27.5	26	27	3.5	72(40)	19(8.6)	
	50	110/220	1.3/0.65	8.6/4.3	22	21	23	1.75	65(35)		
3 Phase 1 Phase VFC100A-7W	60	200-240/400-480	0.53-0.52/0.27-0.26	2.0-2.4/1.0-1.2	26.5	25	27	3.5	72(40)		
	50	190-230/380-460	0.4-0.46/0.2-0.23	2.2-2.6/1.1-1.3	20	19	22	1.75	65(35)		

ACCESSORIES *For additional accessories: See pages 28-37.*

Description	Vacuum Relief Valve	Pressure Relief Valve	Inlet Filter	Inlet Filter Cover	Inlet Filter/Receiver	Exhaust Silencer/Muffler
Model No.	Not Req'd	Not Req'd	F-123	C-123	R15P1.5	VFY-021A

NOTE: Maximum allowable time at deadhead is 600 seconds



VFC10 PERFORMANCE DATA

KEY

— 60 Hz
— 50 Hz

PRESSURE

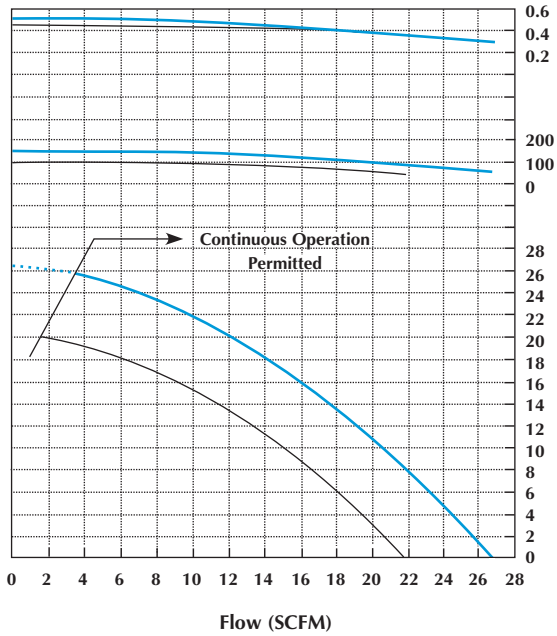

VACUUM

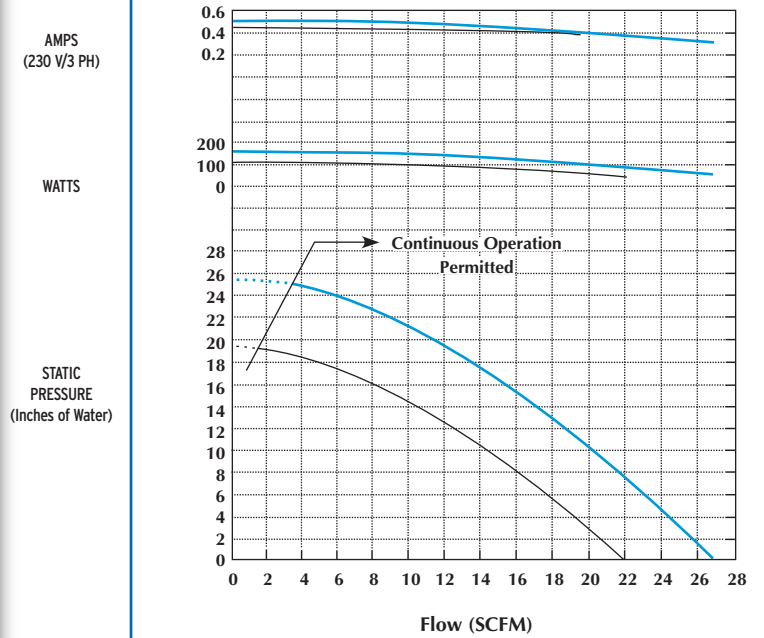

TEMPERATURE RISE

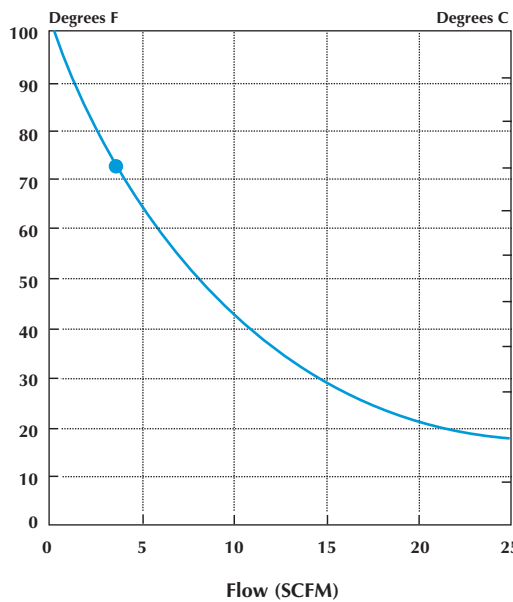

SOUND LEVEL

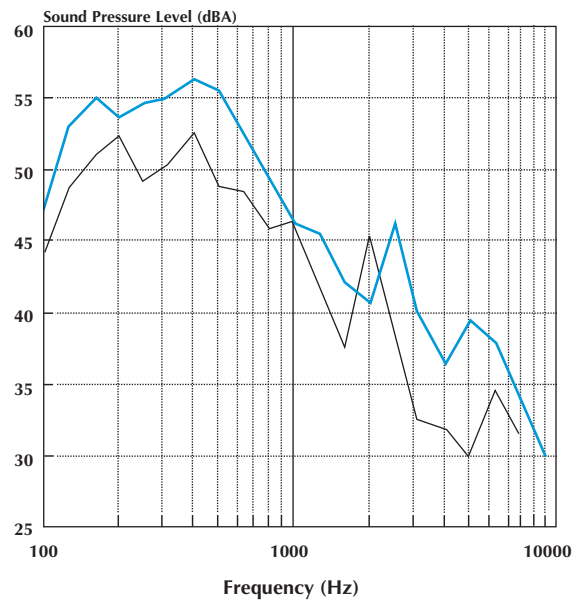

Max. Air Temperature is Value Marked • plus 40 Degrees C Ambient Temperature

*Measured at distance of 1.0 meters



VFC20

RING COMPRESSOR



3-Phase version shown
Contact factory for other versions

The VFC20 is a single-stage ring compressor with a maximum pressure of 37 in. H₂O, a maximum vacuum of 34 in. H₂O, and a maximum capacity of 42 SCFM. It comes complete with a direct-drive, 1/3 horsepower, TEFC motor capable of operating on a wide range of voltages, and on 50 or 60 Hz. A pilot-duty thermal protector is standard equipment on all 3-phase models, and built-in automatic reset thermal protectors on 1-phase units. All versions have NEMA class B insulation, are UL recognized, CSA certified and CE.

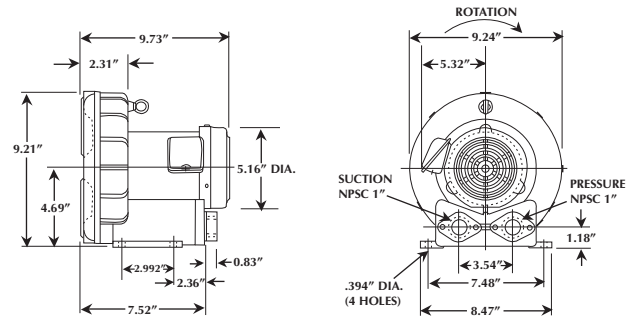

SPECIFICATIONS

Model No.	Hz	Voltage		Amps (Max. Rated)		Amps (Locked Rotor)		Max. Pressure	Max. Vacuum	Max. Airflow	Min. Airflow	Max. Temp Rise (ΔT)	Weight
		Low Voltage	High Voltage	(Max. Rated)	(Locked Rotor)	in. H ₂ O	in. H ₂ O	SCFM	SCFM	°F(°C)	lbs.(kg)		
3 Phase VFC200P-5T	60	115/230		3.6/1.8	11/5.5	34	33	42	3.5	72(40)	22(10)		
	50	110/220		3.0/1.5	10/5	26	25	35	3.5	65(35)			
3 Phase VFC200A-7W	60	200-240/400-480		1.2-1.2/0.6-0.6	5.2-6.0/2.6-3.0	37	34	42	3.5	72(40)	22(10)		
	50	190-230/380-460		1.0-1.1/0.5-0.55	5.8-6.6/2.9-3.3	26	25	35	3.5	65(35)			

ACCESSORIES

Description	Vacuum Relief Valve	Pressure Relief Valve	Inlet Filter	Inlet Filter Cover	Inlet Filter/Receiver	Exhaust Silencer/Muffler
Model No.	Not Req'd	Not Req'd	F-123	C-123	R15P	VFY-021A

NOTE: Maximum allowable time at deadhead is 240 seconds.



VFC20 PERFORMANCE DATA

KEY

— 60 Hz
— 50 Hz

PRESSURE

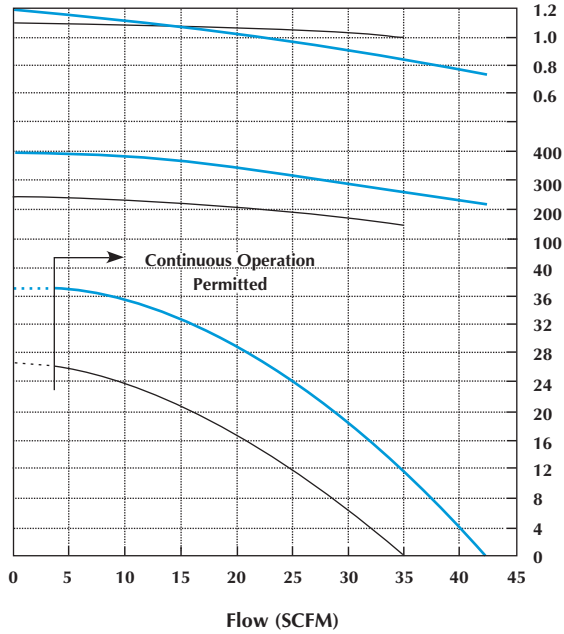

VACUUM

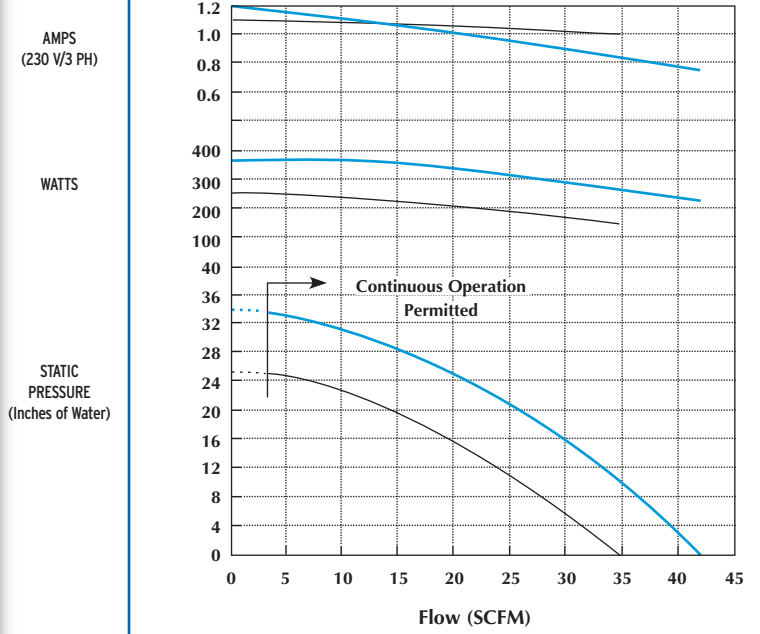

TEMPERATURE RISE

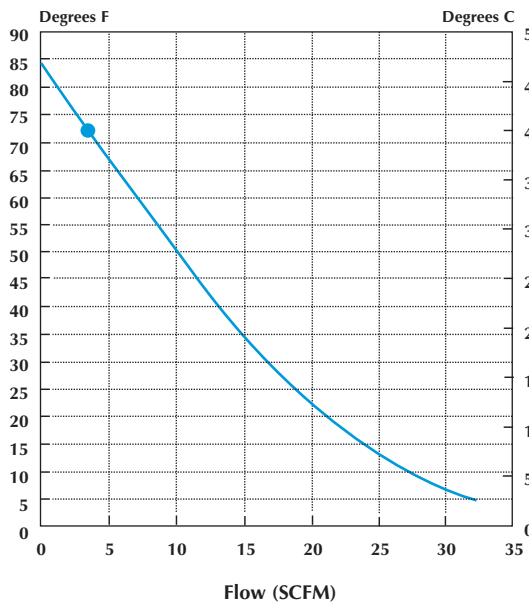

SOUND LEVEL

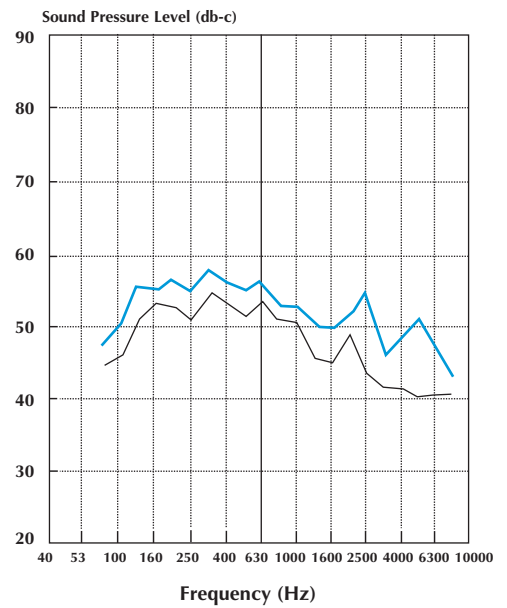

Max. Air Temperature is Value Marked • plus 40 Degrees C Ambient Temperature

*Measured at distance of 1.0 meters



VFC30

RING COMPRESSOR



The VFC30 is a single-stage ring compressor with a maximum pressure of 50 in. H₂O, a maximum vacuum of 45 in. H₂O, and a maximum capacity of 56 SCFM. It comes complete with a direct-drive, 1/2 horsepower, TEFC motor capable of operating on a wide range of voltages, and on 50 or 60 Hz. A pilot-duty thermal protector is standard equipment on all 3-phase models, and built-in automatic reset thermal protectors on 1-phase units. All versions have NEMA class B insulation, are UL recognized, CSA certified, and CE. 575 Volt units are CSA certified only.

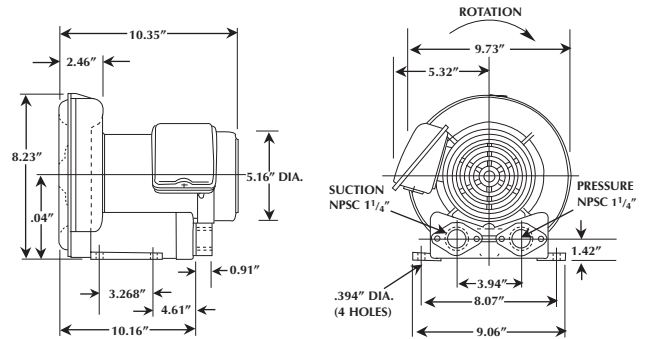

SPECIFICATIONS

Model No.		Hz	Voltage	Amps (Max. Rated)	Amps (Locked Rotor)	Max. Pressure	Max. Vacuum	Max. Airflow	Min. Airflow	Max. Temp Rise (ΔT)	Weight
			Low Voltage/High Voltage		in. H ₂ O	in. H ₂ O	SCFM	SCFM	°F(°C)	lbs.(kg)	
1 Phase	VFC300P-5T	60	115/230	5.0/2.5	17/8.5	49	45	56	17	54(30)	27(12.3)
		50	110/220	3.8/1.9	15/7.5	38	34	49	10	47(27)	
3 Phase	VFC300A-7W	60	200-240/400-480	1.5-1.7/0.75-0.85	7.2-8/3.6-4	50	45	55	17	54(30)	25.5(11.5)
		50	190-230/380-460	1.4-1.7/0.7-0.85	8-8.8/4-4.4	40	36	47	10	47(27)	
	VFC300A-5W	60	575	0.75	3.8	50	45	55	17	54(30)	25.5(11.5)

ACCESSORIES

Description	Vacuum Relief Valve	Pressure Relief Valve	Inlet Filter	Inlet Filter Cover	Inlet Filter/Receiver	Exhaust Silencer/Muffler
Model No.	VV3	PV3	F-123	C-123	R15P1.5	VFY-023A



NOTE: Maximum allowable time at deadhead is 120 seconds.

VFC30 PERFORMANCE DATA

KEY

— 60 Hz
— 50 Hz

PRESSURE

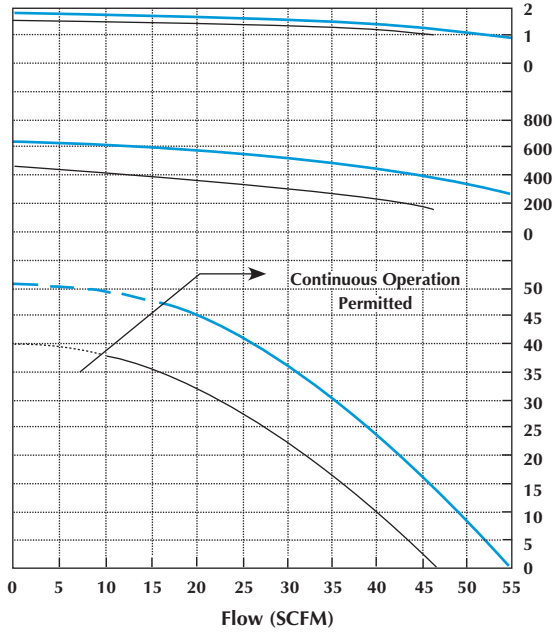

VACUUM

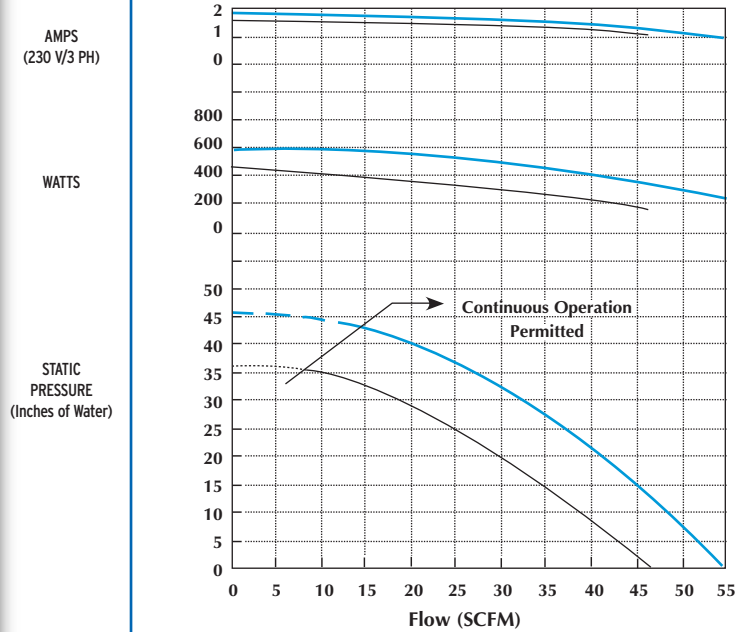

TEMPERATURE RISE

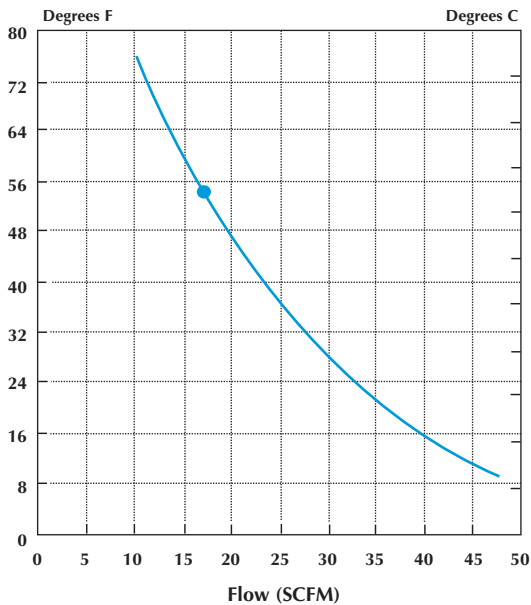

SOUND LEVEL

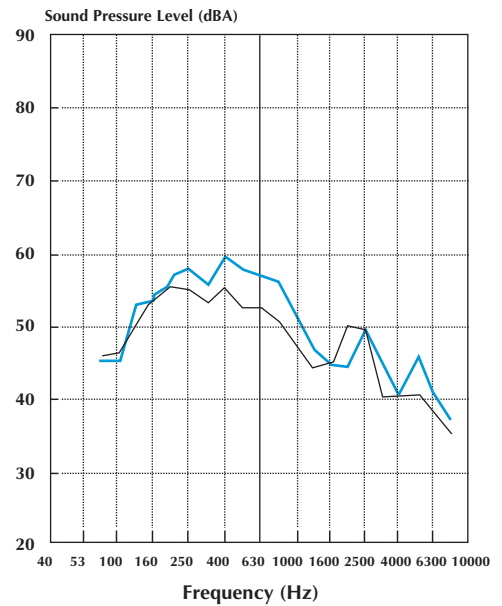

Max. Air Temperature is Value Marked • plus 40 Degrees C Ambient Temperature

*Measured at distance of 1.0 meter



VFC40

RING COMPRESSOR



The VFC40 is a single-stage ring compressor with a maximum pressure of 54.5 in. H₂O, a maximum vacuum of 50 in. H₂O, and a maximum capacity of 98 SCFM. It comes complete with a direct-drive, 1 horsepower, TEFC motor capable of operating on a wide range of voltages, and on 50 or 60 Hz. A pilot-duty thermal protector is standard equipment on all 3-phase and 1-phase models. All versions have NEMA class B insulation, are UL recognized, CSA certified, and CE. 575V units are CSA certified only.

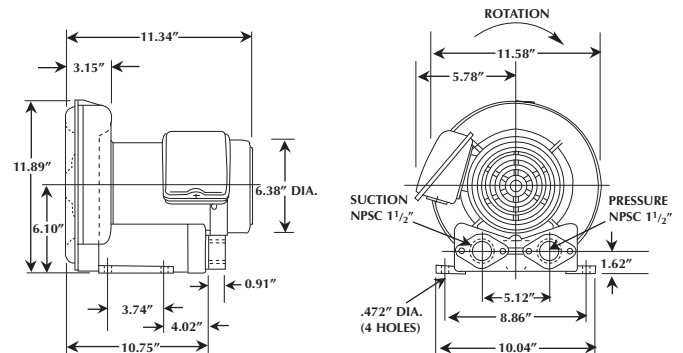

SPECIFICATIONS

Model No.	Hz	Voltage	Amps		Max. Pressure in. H ₂ O	Max. Vacuum in. H ₂ O	Max. Airflow SCFM	Min. Airflow SCFM	Max. Temp Rise (ΔT) °F(°C)	Weight lbs.(kg)
			(Max. Rated)	(Locked Rotor)						
1 Phase VFC400P-5T	60	115/230	8.6/4.3	24/12	54.5	50	98	3.5	119(65)	51(23)
	50	110/220	6.0/3.0	22/11	40	37	84	3.5	101(55)	
3 Phase VFC400A-7W	60	200-240/400-480	3.3-2.8/1.7-1.4	15-16.5/7.4-8.2	54.5	50	98	3.5	119(65)	47.5(21.5)
	50	190-230/380-460	2.2-2.4/1.1-1.2	16.5-18.5/8.3-9.2	40	37	84	3.5	101(55)	
VFC400A-5W	60	575	1.3	7.2	54.5	50	98	3.5	119(65)	47.5(21.5)

ACCESSORIES

Description	Vacuum Relief Valve	Pressure Relief Valve	Inlet Filter	Inlet Filter Cover	Inlet Filter/Receiver	Exhaust Silencer/Muffler
Model No.	VV4	PV4	F-45	C-45	R30P1.5	VFY-024A



NOTE: Maximum allowable time at deadhead is 120 seconds.

VFC40 PERFORMANCE DATA

KEY

— 60 Hz
— 50 Hz

PRESSURE

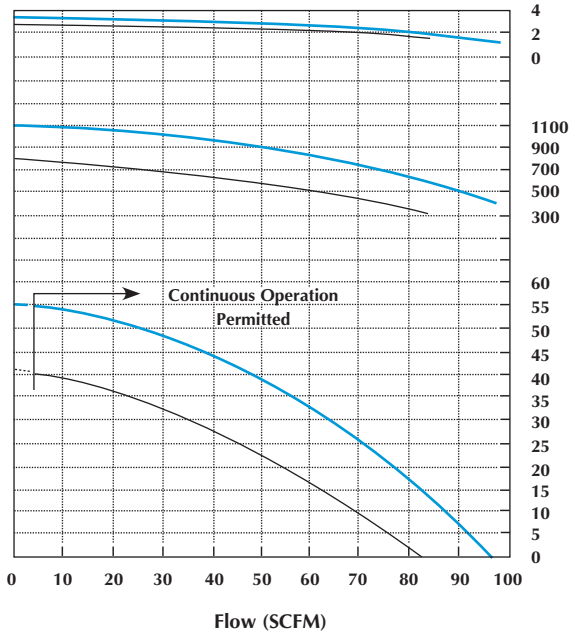

VACUUM

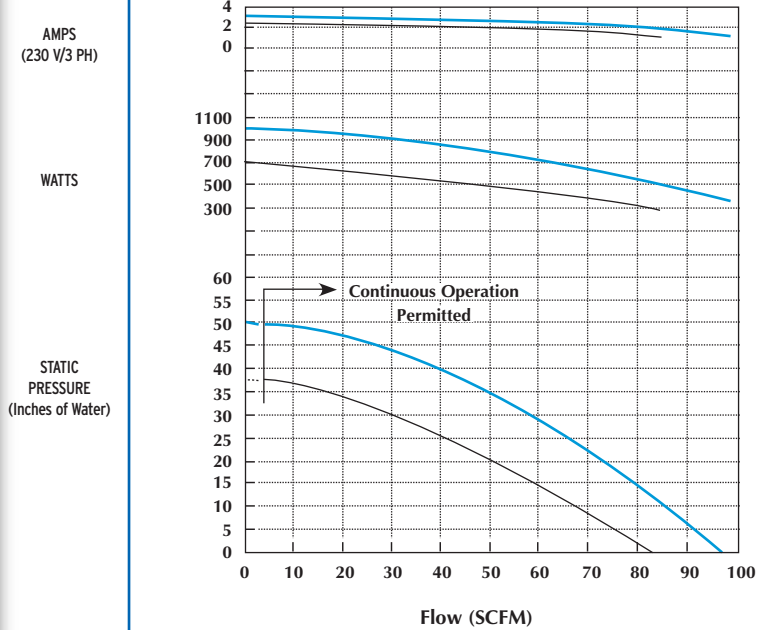

TEMPERATURE RISE

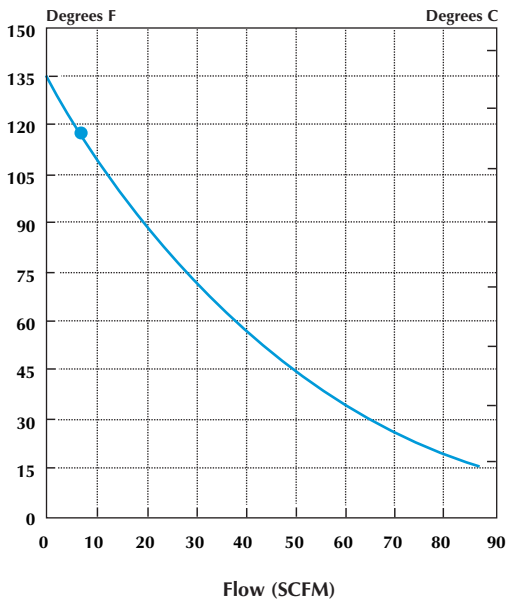

SOUND LEVEL

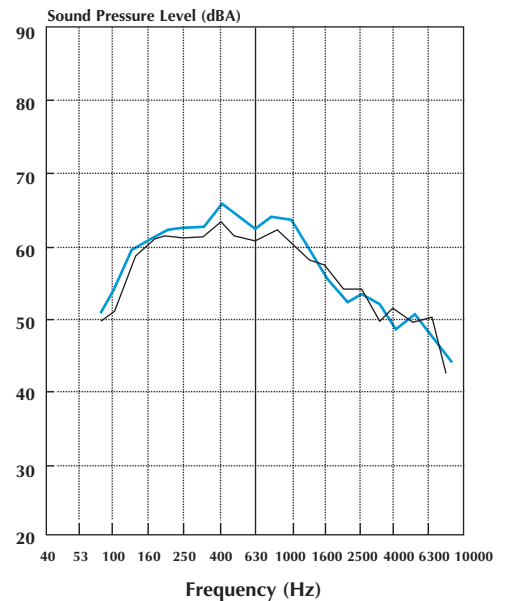

Max. Air Temperature is Value Marked • plus 40 Degrees C Ambient Temperature

*Measured at distance of 1.0 meter



The VFC50 is a singlestage ring compressor with a maximum pressure of 80 in. H₂O, a maximum vacuum of 70 in. H₂O, and a maximum capacity of 154 SCFM. It comes complete with a direct-drive, 2.5 horsepower, TEFC motor capable of operating on a wide range of voltages, and on 50 or 60 Hz. A pilot-duty thermal protector is standard equipment on all 3-phase and 1-phase models. All versions have NEMA class B insulation, are UL recognized, CSA certified, and CE. 575 Volt units are CSA certified only.

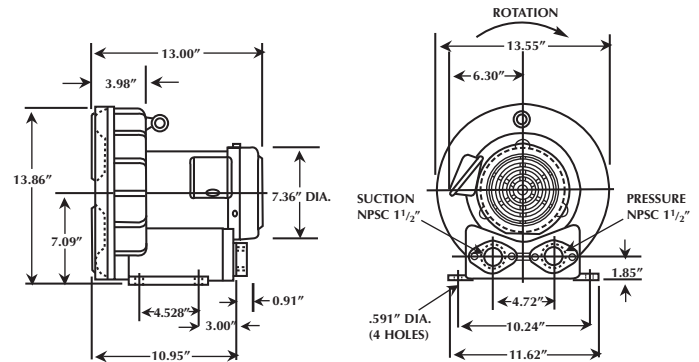

SPECIFICATIONS

Model No.	Hz	Voltage	Amps		Max. Pressure	Max. Vacuum	Max. Airflow	Min. Airflow	Max. Temp Rise (ΔT)	Weight
			(Max. Rated)	(Locked Rotor)						
1 Phase VFC508P-2T	60	200/230	12-11	70-80	80	70	154	60	72(40)	97.5(44)
	50	200/230	8.5-8	70-75	60	53	130	45	65(35)	
3 Phase VFC500A-7W	60	200-240/400-480	6.9-6.2/3.4-3.1	44-52/22-26	80	70	154	45	101(55)	70.5(32)
	50	190-230/380-460	5.2-5.4/2.6-2.7	48-56/24-28	60	53	130	25	72(40)	
VFC500A-5W	60	575	2.3	21	80	70	154	45	119(65)	70.5 (32)

ACCESSORIES

Description	Vacuum Relief Valve	Pressure Relief Valve	Inlet Filter	Inlet Filter Cover	Inlet Filter/Receiver	Exhaust Silencer/Muffler
Model No.	VV5	PV5	F-45	C-45	R30P1.5	VFY-024A



NOTE: Maximum allowable time at deadhead is 60 seconds.

VFC50 PERFORMANCE DATA

KEY

— 60 Hz
— 50 Hz

PRESSURE

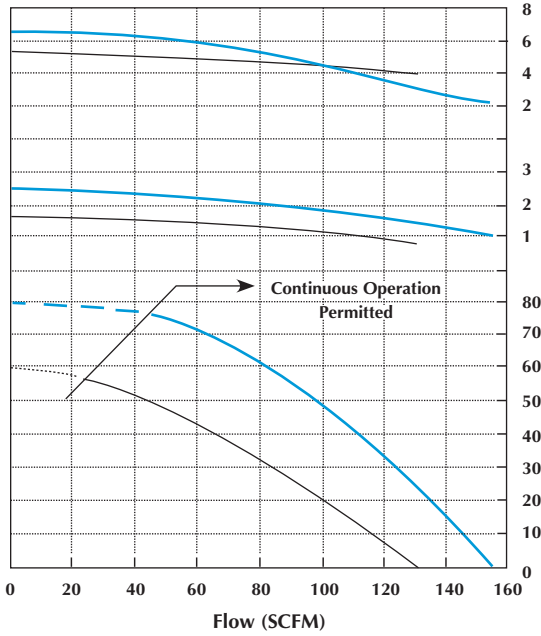

VACUUM

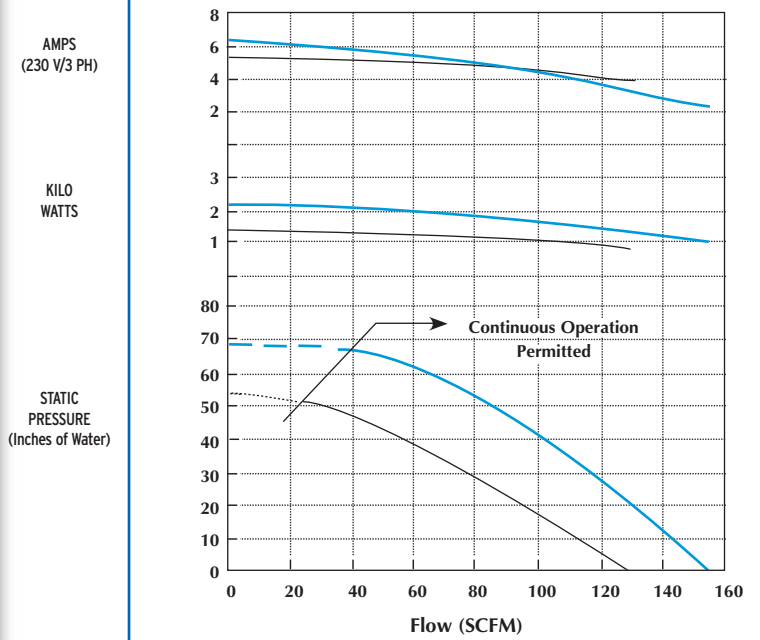

TEMPERATURE RISE

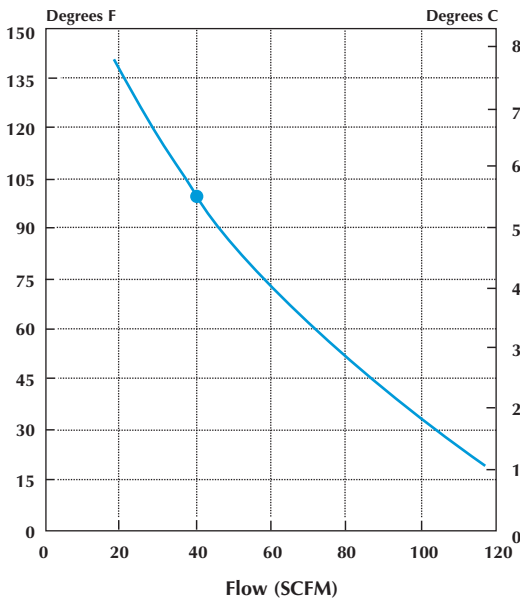

SOUND LEVEL

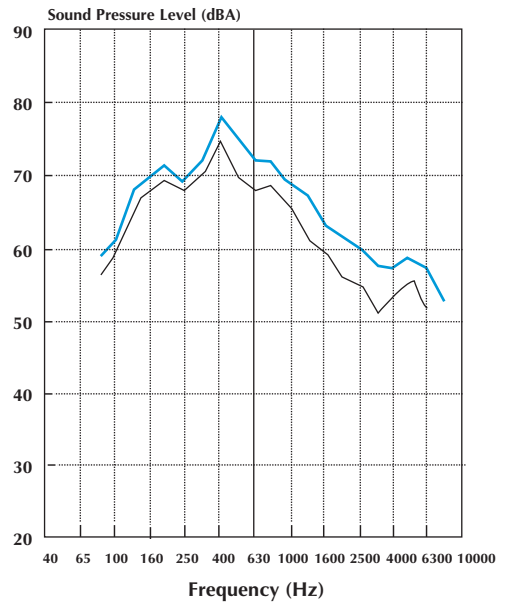

Max. Air Temperature is Value Marked • plus 40 Degrees C Ambient Temperature

*Measured at distance of 1.0 meter



The VFC60 is a single-stage ring compressor with a maximum pressure of 118 in. H₂O, a maximum vacuum of 98 in. H₂O, and a maximum capacity of 206 SCFM. It comes complete with a direct-drive, 4.5 horsepower TEFC motor capable of operating on a wide range of voltages, and on 50 or 60 Hz. A pilot-duty thermal protector is standard equipment on all 3-phase models. All versions have NEMA class B insulation, are UL recognized, CSA certified, and CE. 575 Volt units are CSA certified only.

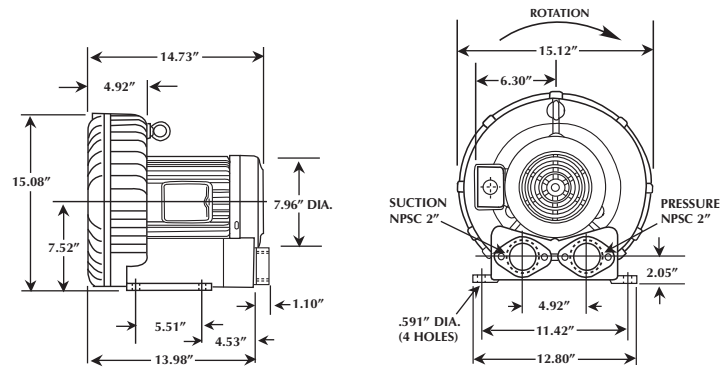

SPECIFICATIONS

Model No.	Hz	Voltage	Amps		Max. Pressure in. H ₂ O	Max. Vacuum in. H ₂ O	Max. Airflow SCFM	Min. Airflow SCFM	Max. Temp Rise (ΔT) °F(°C)	Weight lbs.(kg)
			(Max. Rated)	(Locked Rotor)						
3 Phase VFC600A-7W	60	200-240/400-480	12-11/6.0-5.5	78-90/39-45	118	98	206	56	126(70)	114(52)
	50	190-230/380-460	9.2-10.5/4.6-5.2	88-102/44-51	86	72	175	28	108(65)	
VFC600A-5W	60	575	4.4	36	118	98	206	56	126(70)	114(52)

ACCESSORIES

Description	Vacuum Relief Valve	Pressure Relief Valve	Inlet Filter	Inlet Filter Cover	Inlet Filter/Receiver	Exhaust Silencer/Muffler
Model No.	VV6	PV6	F-67	C-67	R30P2.0	VFY-026A



NOTE: Maximum allowable time at deadhead is 60 seconds.

VFC60 PERFORMANCE DATA

KEY

- 60 Hz
- 50 Hz

PRESSURE

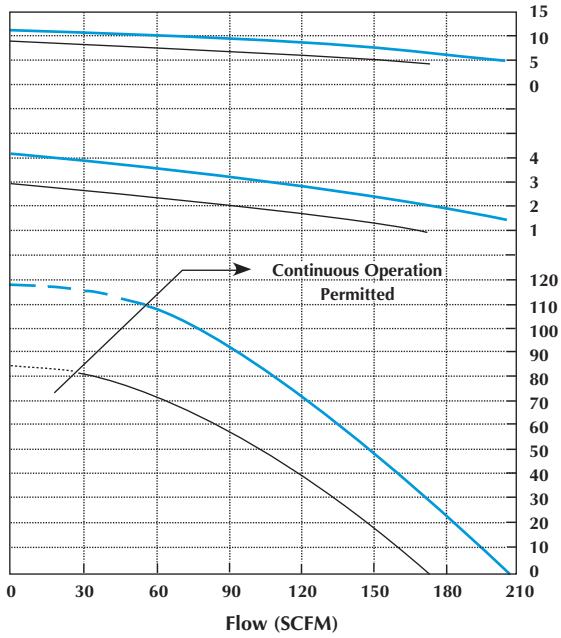

VACUUM

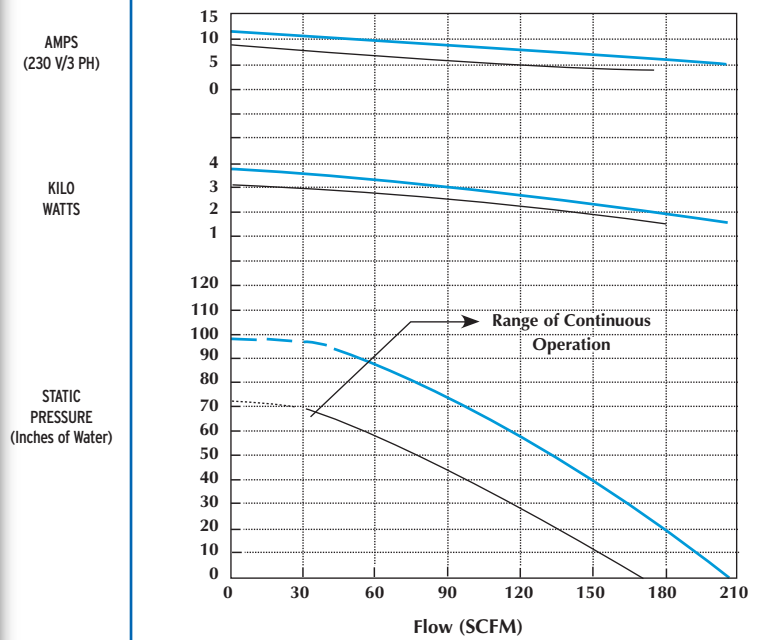

TEMPERATURE RISE

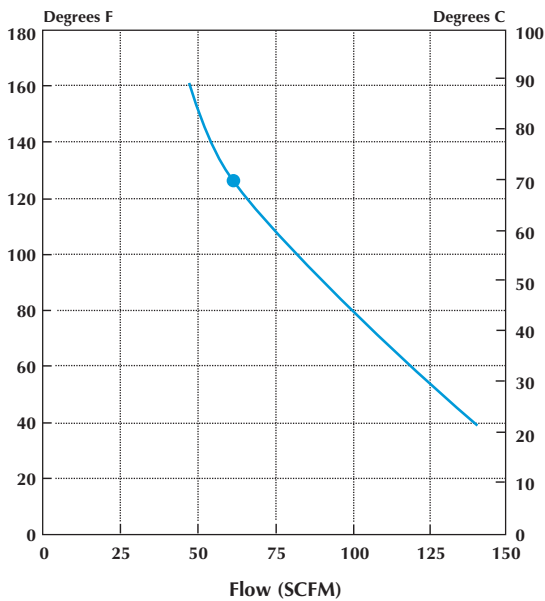

SOUND LEVEL

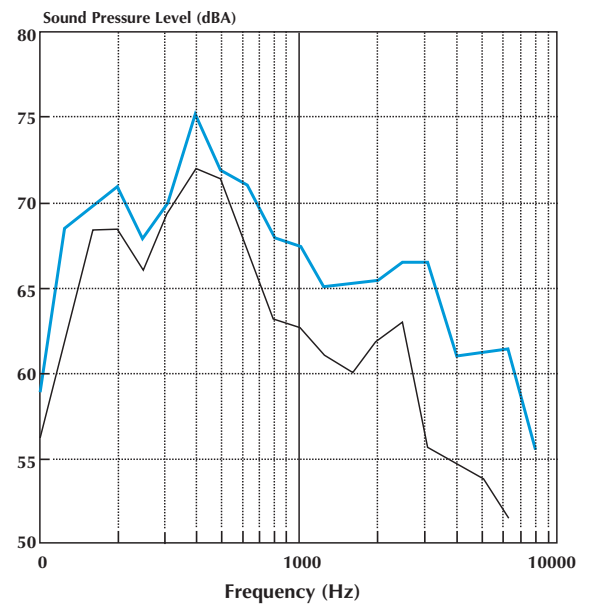

Max. Air Temperature is Value Marked • plus 40 Degrees C Ambient Temperature

*Measured at distance of 1.0 meter



The VFC70 is a single-stage ring compressor with a maximum pressure of 114 in. H₂O, a maximum vacuum of 96 in. H₂O and a maximum capacity of 267 SCFM. It comes complete with a direct-drive, 7 horsepower, TEFC motor capable of operating on a wide range of voltages, and on 50 or 60 Hz. A pilot-duty thermal protector is standard equipment on all 3-phase models. All versions have NEMA class F insulation, and are UL recognized, CSA certified, and CE. 575 Volt units are CSA certified only.

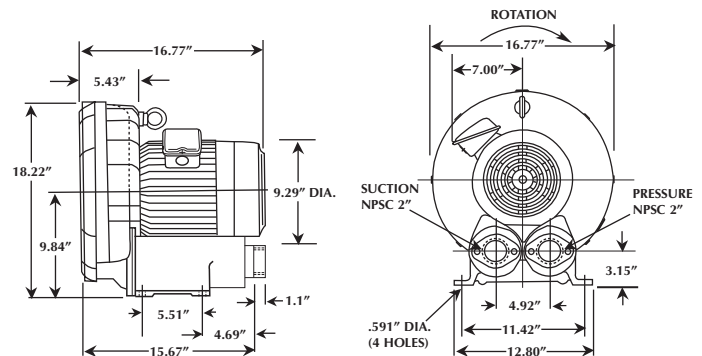

SPECIFICATIONS

Model No.	Hz	Voltage	Amps (Max. Rated)	Amps (Locked Rotor)	Max. Pressure	Max. Vacuum	Max. Airflow	Min. Airflow	Max. Temp Rise (ΔT)	Weight
		Low Voltage/High Voltage		in. H ₂ O	in. H ₂ O	SCFM	SCFM	°F(°C)	lbs.(kg)	
3 Phase VFC700A-7W	60	200-240/400-480	15.6-16/7.8-8.0	110-115/50-58	114	96	267	88	137(75)	180(82)
	50	190-230/380-460	13-14/6.5-7.0	104-128/52-64	81	71	220	63	108(60)	
VFC700A	60	575	6.7	35	114	96	267	88	137(75)	180(82)

ACCESSORIES

Description	Vacuum Relief Valve	Pressure Relief Valve	Inlet Filter	Inlet Filter Cover	Exhaust Silencer/Muffler
Model No.	VV7	PV7	F-67	C-67	VFY-026A



NOTE: Maximum allowable time at deadhead is 30 seconds.

VFC70 PERFORMANCE DATA

KEY

— 60 Hz
— 50 Hz

PRESSURE

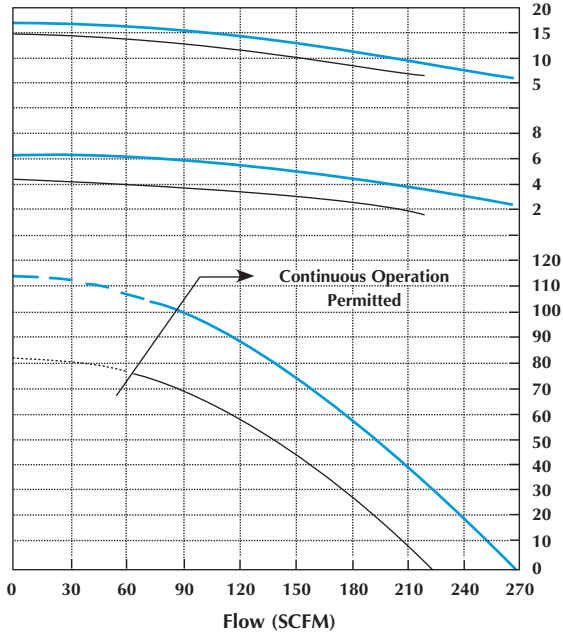

VACUUM

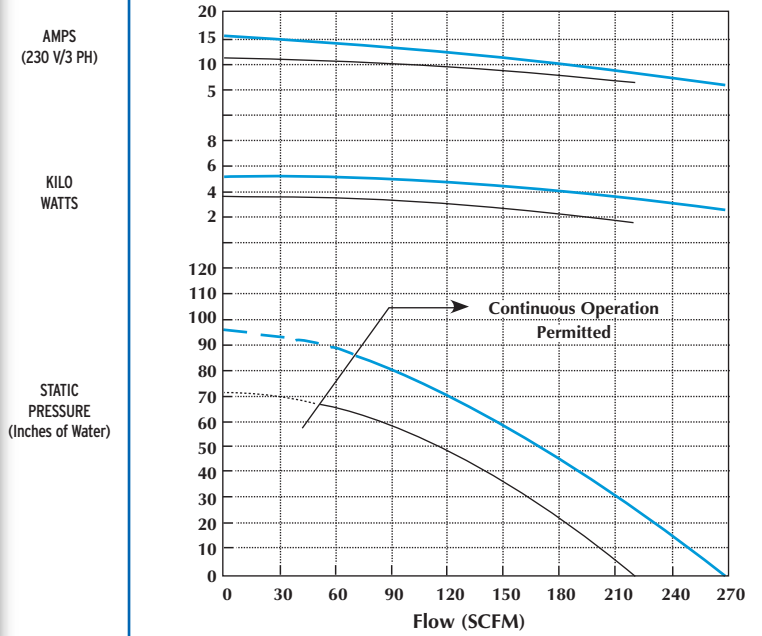

TEMPERATURE RISE

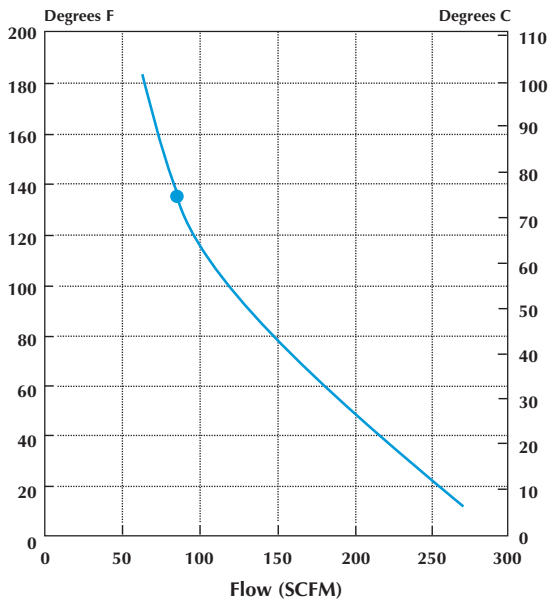

SOUND LEVEL

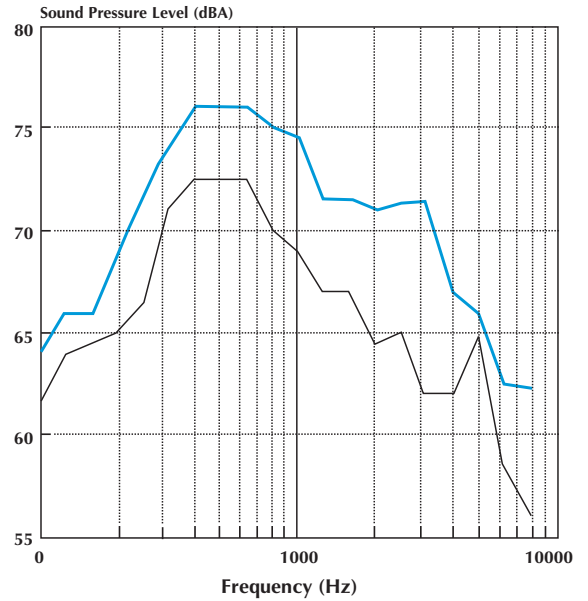

Max. Air Temperature is Value Marked • plus 40 Degrees C Ambient Temperature

*Measured at distance of 1.0 meter



The VFC80 is a single-stage ring compressor with a maximum pressure of 135 in. H₂O, a maximum vacuum of 110 in. H₂O, and a maximum capacity of 388 SCFM. It comes complete with a direct-drive, 10 horsepower, TEFC motor capable of operating on a wide range of voltages, and on 50 or 60 Hz. A pilot-duty thermal protector is standard equipment on all 3-phase models. All versions have NEMA class B insulation, and are UL recognized, CSA certified, and CE. 575 Volt units are CSA certified only.

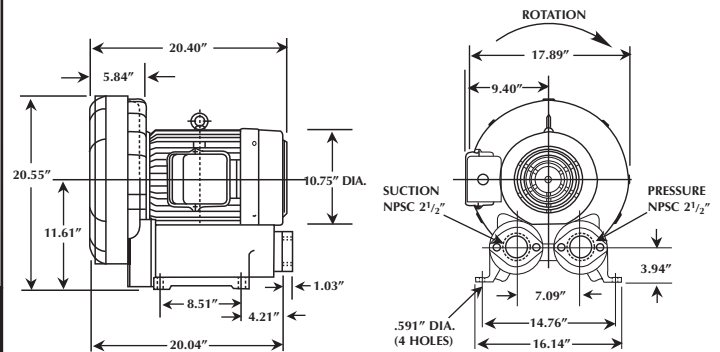

SPECIFICATIONS

Model No.		Hz	Voltage	Amps (Max. Rated)	Amps (Locked Rotor)	Max. Pressure in. H ₂ O	Max. Vacuum in. H ₂ O	Max. Airflow SCFM	Min. Airflow SCFM	Max. Temp Rise (ΔT) °F(°C)	Weight lbs.(kg)
3 Phase	VFC804A-7W	60	200-240/400-480	26-23/13-11.5	144-160/72-80	135	110	388	135	137(75)	287(130)
		50	190-230/380-460	18-19/9.0-9.5	164-190/82-95	100	83	320	88	137(75)	
	VFC804A-5W	60	575	9.2	66	135	110	388	135	137(75)	287(130)

ACCESSORIES

Description	Vacuum Relief Valve	Pressure Relief Valve	Inlet Filter	Inlet Filter Cover	Exhaust Silencer/Muffler
Model No.	VV8	PV8	F-89	C-89	VFY-028A



NOTE: Maximum allowable time at deadhead is 30 seconds.

VFC80 PERFORMANCE DATA

KEY

— 60 Hz
— 50 Hz

PRESSURE

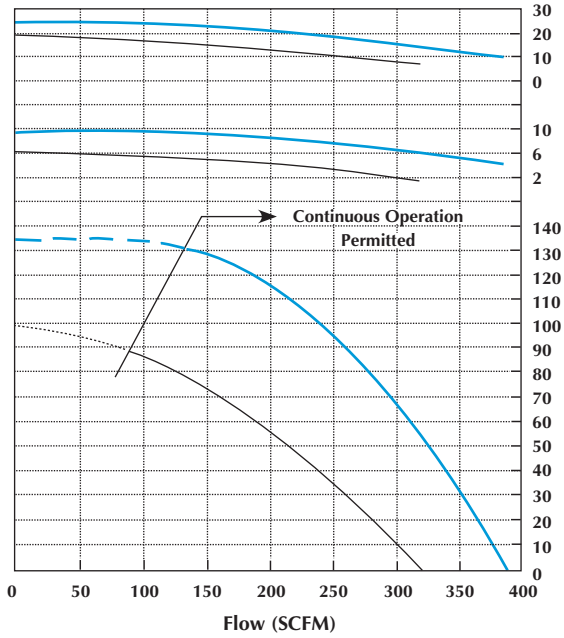

VACUUM

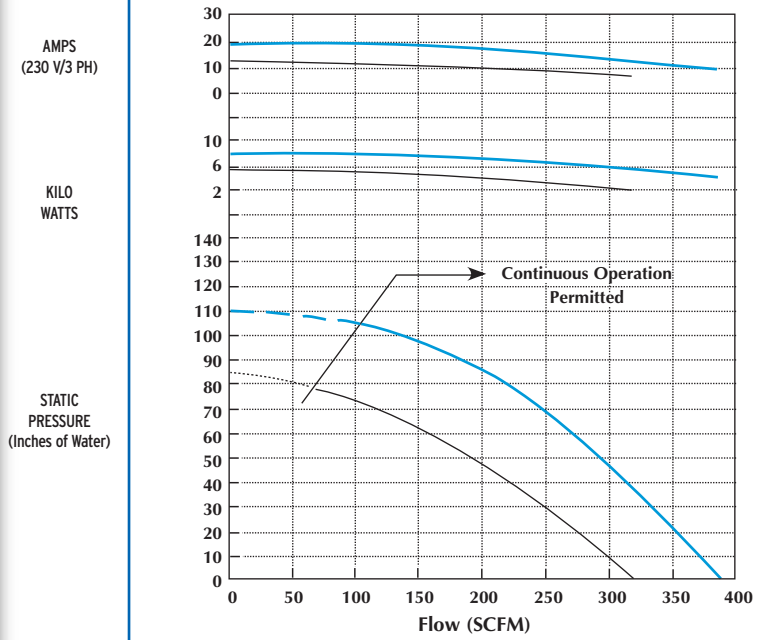

TEMPERATURE RISE

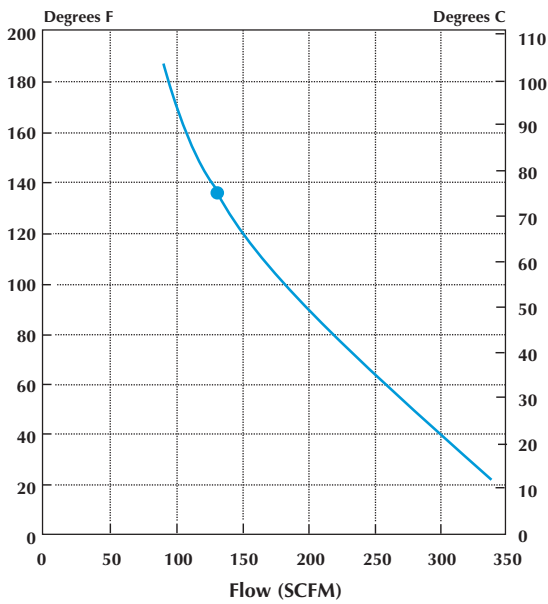

SOUND LEVEL

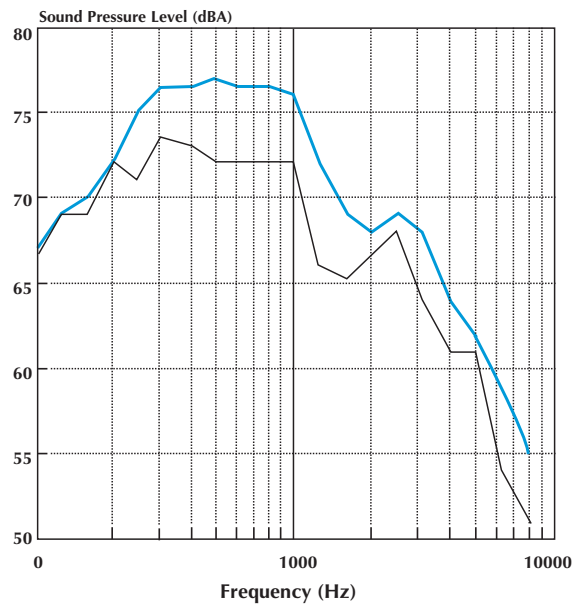

Max. Air Temperature is Value Marked • plus 40 Degrees C Ambient Temperature

*Measured at distance of 1.0 meter



The VFC90 is a single-stage ring compressor with a maximum pressure of 139 in. H₂O, a maximum vacuum of 100 in. H₂O, and a maximum capacity of 570 SCFM. It comes complete with a direct-drive, 20 horsepower, TEFC motor capable of operating on a wide range of voltages and on 50 or 60 Hz. A pilot-duty thermal protector is standard equipment on all 3-phase models. All versions have NEMA class B insulation, and are UL recognized, CSA certified, and CE. 575 Volt units are CSA certified only.

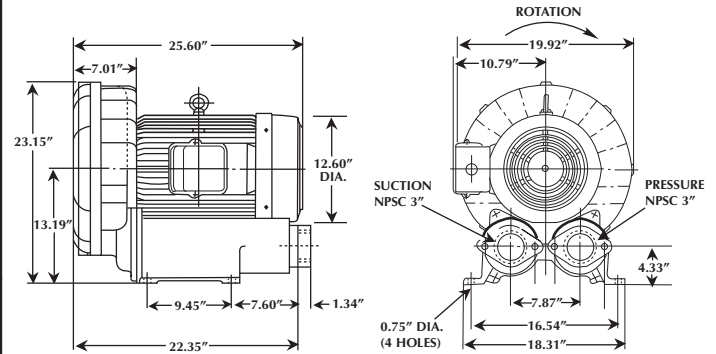

SPECIFICATIONS

Model No.		Hz	Voltage	Amps (Max. Rated)	Amps (Locked Rotor)	Max. Pressure in. H ₂ O	Max. Vacuum in. H ₂ O	Max. Airflow SCFM	Min. Airflow SCFM	Max. Temp Rise (ΔT) °F(°C)	Weight lbs.(kg)
3 Phase	VFC904A-7W	60	200-240/400-480	48-44/24-22	290-330/145-165	139	110	570	195	162(90)	450(205)
		50	190-230/380-460	32-28/16-14	310-350/155-175	90	75	500	140	155(85)	
	VFC904A-5W	60	575	16	130	139	110	570	195	162(90)	450(205)

ACCESSORIES

Description	Vacuum Relief Valve	Pressure Relief Valve	Inlet Filter	Inlet Filter Cover	Exhaust Silencer/Muffler
Model No.	VV9	PV9	F-89	C-89	VFY-029A

NOTE: Maximum allowable time at deadhead is 30 seconds.



VFC90 PERFORMANCE DATA

KEY

— 60 Hz
— 50 Hz

PRESSURE

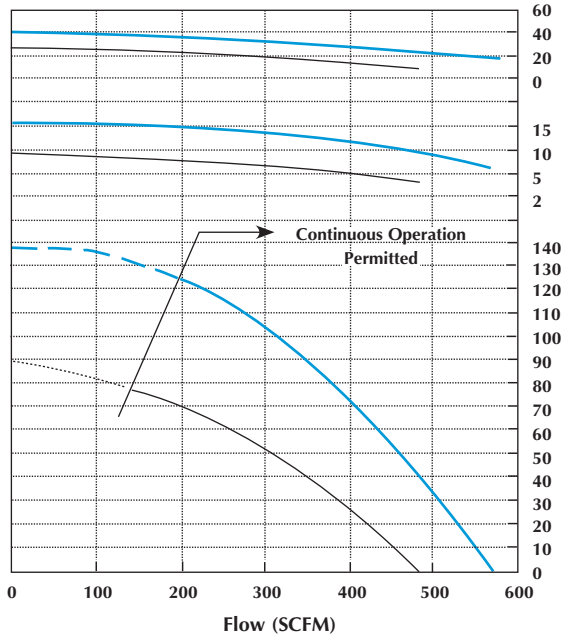

VACUUM

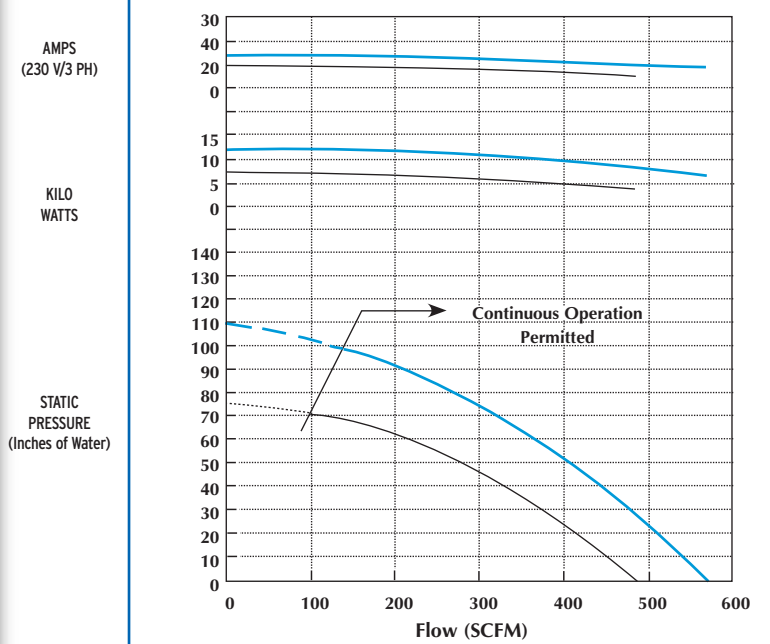

TEMPERATURE RISE

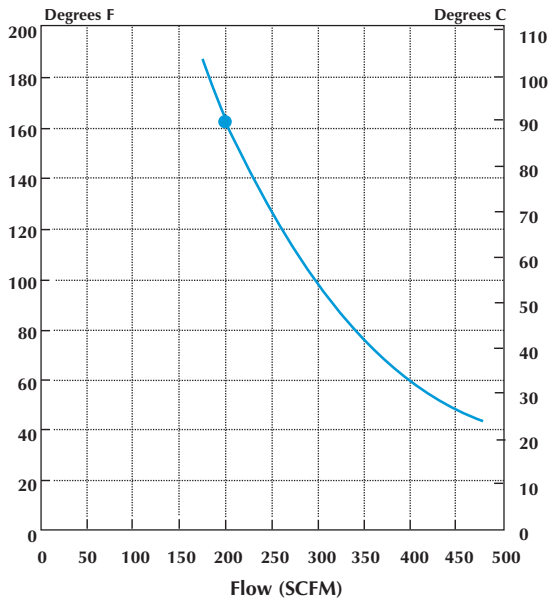

SOUND LEVEL

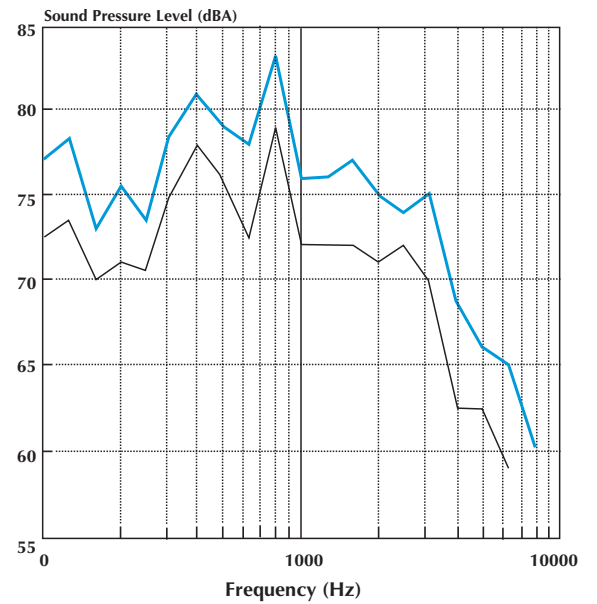

Max. Air Temperature is Value Marked • plus 40 Degrees C Ambient Temperature

*Measured at distance of 1.0 meter

ASPIRATORS

Some applications require conveying of a product to a remote point. The use of an aspirator permits lightweight product to be conveyed by vacuum and then blown to a remote point without risk of any product getting to the blower.

Aspirator are ideal for applications such as transporting lightweight materials such as paper trim, textile trim, film, dust, etc.



(X) Motive air; (Y) Product pick-up with vacuum flow; (Z) Air exhaust from "X" and material from "Y"

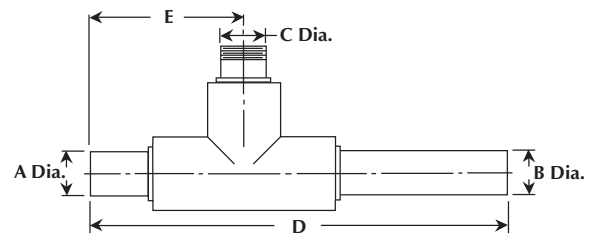

ASPIRATORS						
Model No.	A Dim. (Hose*)	A Dim. (Pipe*)	B Dim. (Hose/Pipe*)	C Dim. (in.) (Hose/Pipe*)	D Dim.** (in.)	E Dim.** (in.)
CA100	1 1/4"	1"	1 1/2"	1 1/2"	11"	4"
CA125	1 1/2"	1 1/4"	2"	1 1/2"	14"	5 1/2"
CA150	2"	1 1/2"	2 1/2"	1 1/2"	16"	6"
CA200	2 1/2"	2"	3"	1 1/2", 2"	19"	6"
CA250	2 1/2"	2 1/2"	3", 4"	2", 2 1/2"	24"	8"
CA300	3 1/2"	3"	4"	2 1/2", 3"	27"	9"

* Hose or Pipe (Specify)

** Dimensions D and E are approximate

BLOWER/ASPIRATORS COMBINATIONS

Aspirator Inlet Pressure -vs- Discharge Flow (Tested with 30 ft. hose)

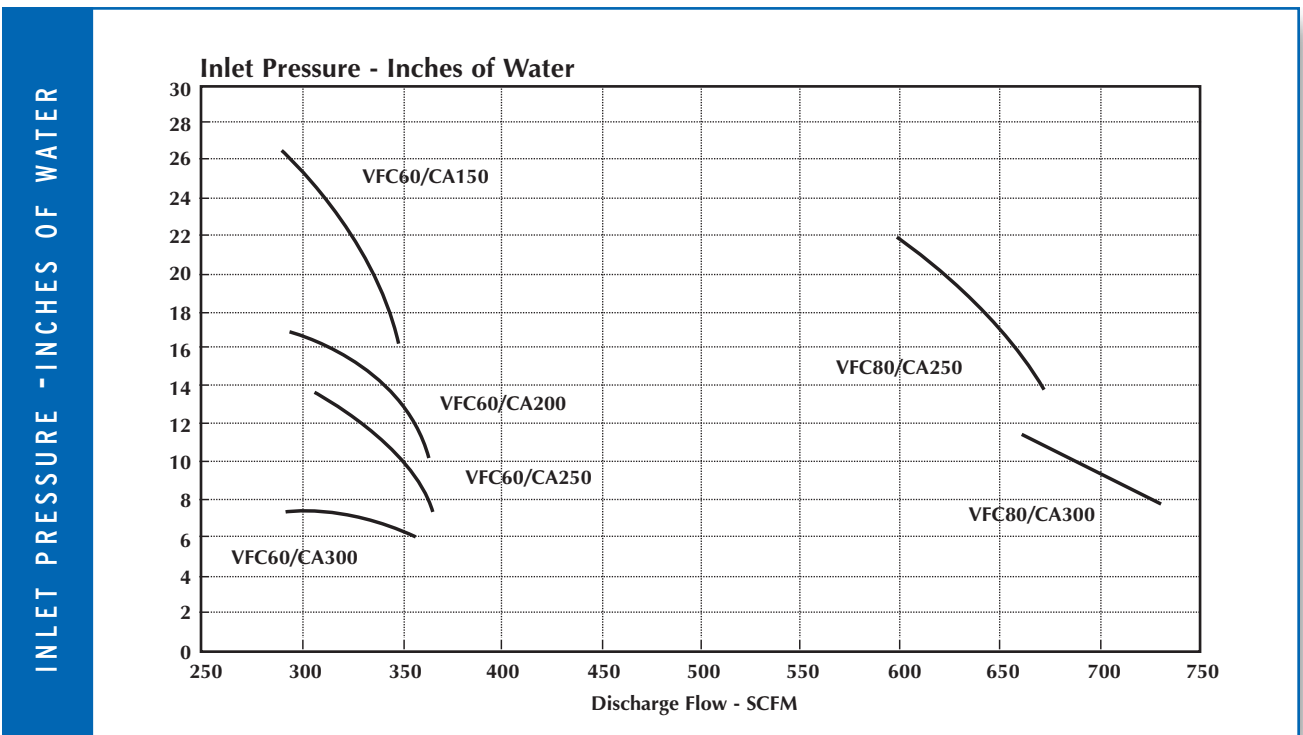
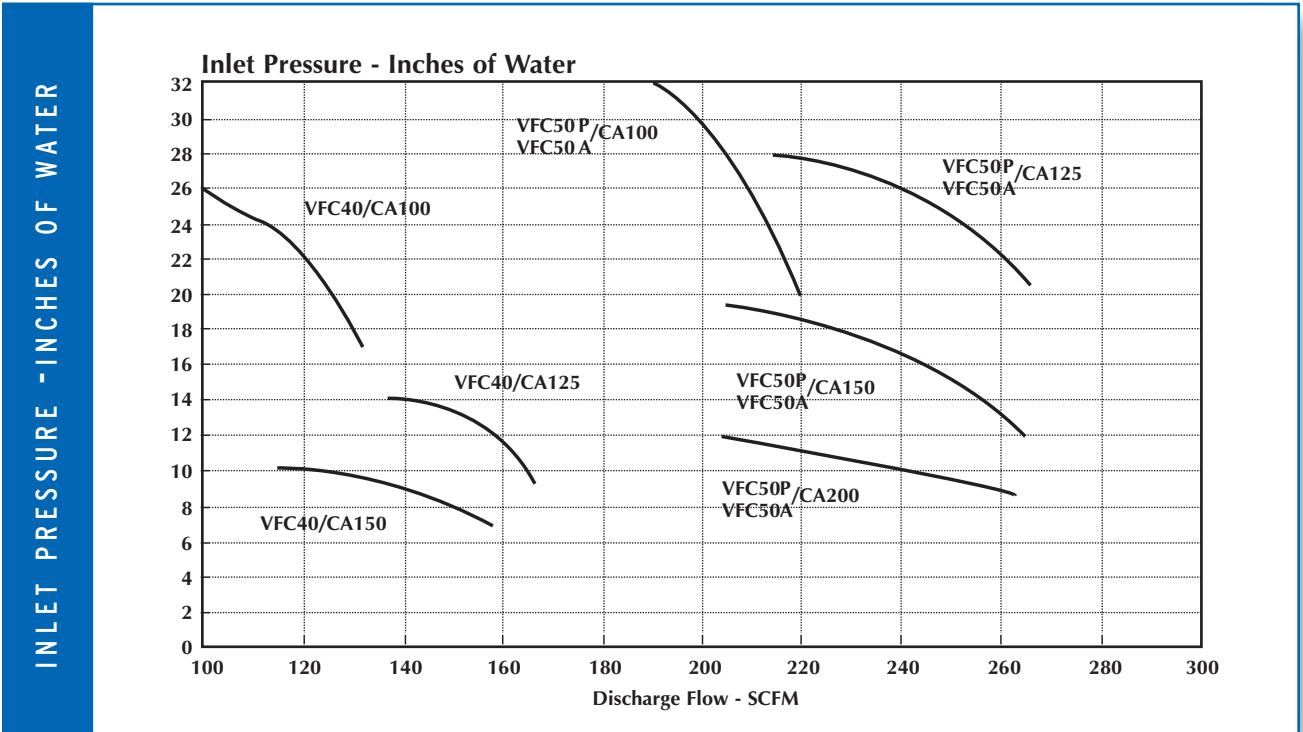

EXHAUST SILENCERS (MUFFLER)

Although the Fuji Ring Compressors are very quiet during operation, there are times when an additional exhaust silencer may be needed. These silencers allow quieter operation of the blowers in environments where noise levels are critical. The exhaust silencer reduces the noise level by approximately 5 dBA.

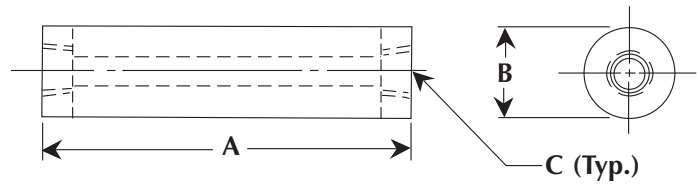

EXHAUST SILENCERS (MUFFLERS)				
Filter Model	For Use With Blower Model:	A Dim. (in.)	B Dim. (in.)	C Dim. (in.)
VFY-021A	VFC06-VFC20	12"	2 1/2"	1" FPT
VFY-023A	VFC30	12"	2 1/2"	1 1/4" FPT
VFY-024A	VFC40-VFC50	12"	3"	1 1/2" FPT
VFY-026A	VFC60-VFC70	15 3/4"	3 1/2"	2" FPT
VFY-028A	VFC80	21"	4 1/2"	2 1/2" FPT
VFY-029A	VFC90	26"	5"	3" FPT

HIGH VOLUME FILTER/RECEIVERS

Occasionally, an application requires a larger filtration area than the standard Fuji Vacuum Receiver offers. These High Volume Filter / Receivers are constructed with an outer housing made of 16 ga. steel and have an inner liner made of perforated metal, which provides support for a Canton flannel canvas filter bag. An additional, inexpensive, disposable / reusable bag fits inside the flannel bag to provide an easy means to remove the collected material from the receiver. The inlet and outlet connections are for 2" (FR30) and 2 1/2" (FR55) hose. NOTE: Swivel Elbow Inlet is optional.

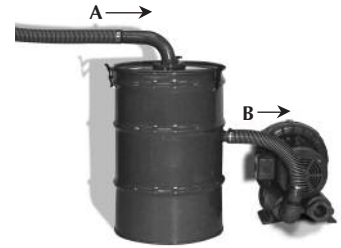

The High Volume Filter / Receivers are designed for use with lightweight materials such as textile lint and dust. It may be used for powders, pellets, etc., but the volume of material collected would be limited due to the weight of the material in the bags. Not intended for use with wet product.

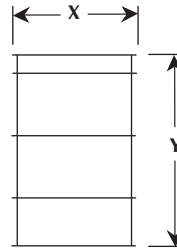

A) Vacuum flow from receiver to blower: (B) Vacuum flow to receiver; (C) Canton flannel filter bag (1 extra with each model); (D) Disposable / Reusable filter (10 with each model).

HIGH VOLUME FILTER/RECEIVER		
Model No.	X Dim. (in.)	Y Dim. (in.)
FR-30	19"	30"
FR-55	23"	36"

CANTON FLANNEL FILTER BAGS

Model No.	For Use With:
FR-30FB	FR-30
FR-55FB	FR-55

DISPOSABLE/REUSABLE FILTER BAGS

Model No.	For Use With:
FR-30DRB	FR-30FB
FR-55DRB	FR-55FB

INLINE FILTER/TRAPS

These Inline Filter Traps are 6" diameter plastic filters with a perforated metal basket and are available in either 12" or 24" lengths. They are used with the Fuji Ring Compressors through model VFC70 for trapping lint, string, paper, etc. 1 1/2" and 2" hose connections are available.

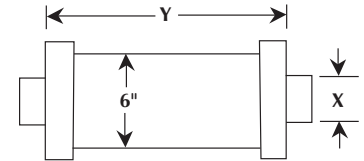

INLINE FILTER TRAPS		
Model No.	X Dim. (in.)	Y Dim. (in.)
TX1215	1 1/2"	12"
TX1220	2"	12"
TX2420	2"	24"

INLET FILTERS

These filters are designed to protect the Fuji Ring Compressor by filtering the inlet air when the blower is being used for pressure applications. The filter has a perforated metal outer cover and an inner liner wrapped with a fine (.009) mesh screen. The filter is rated for 200 micron filtration.

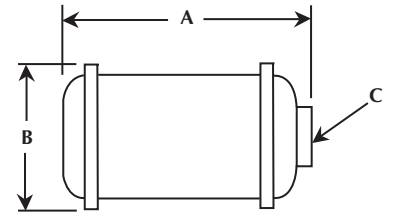

INLET FILTER COVERS

These covers are designed to fit over the inlet filter in order to provide better filter protection. They are made of 100% polyester fibers, are approximately 3/4" thick, and are rated 80% efficient at 25 microns.



INLET FILTER					FILTER COVER
Filter Model	For Use With Blower Model:	A Dim. (in.)	B Dim. (in.)	C Dim. (in.)	Filter Cover Model:
F-123	VFC06-VFC30	7 3/8"	3 7/8"	1 1/4"	FPT C-123
F-45	VFC40-VFC50	8"	5 1/8"	1 1/2"	FPT C-45
F-67	VFC60-VFC70	14"	5 1/8"	2"	FPT C-67
F-89	VFC80-VFC90	23 1/2"	8 1/4"	3"	MPT C-89

Typical Pressure System

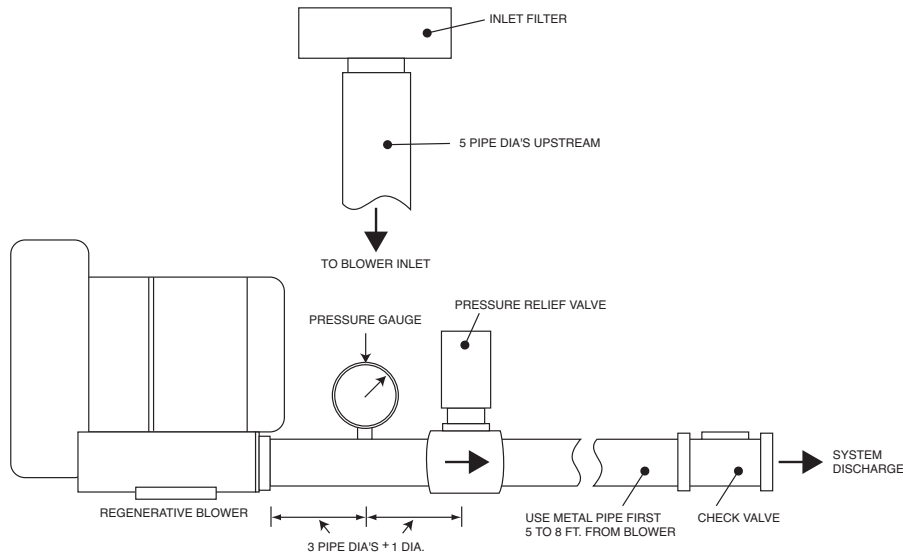

INLET FILTER/SILENCERS

The inlet filter / silencers are designed to protect the Fuji Ring Compressor by filtering the inlet air and quieting the blower when used for pressure applications. The filter has a pleated paper inner filter element rated at 10 microns. A metal outer cover is easily removable when servicing the unit.



REPLACEMENT ELEMENTS

Replacement elements for the Inlet Filter / Silencers are pleated paper elements rated for 10 micron filtration. (Other filter elements available upon request. For example: HEPA & others)

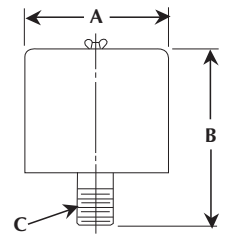

INLET FILTER/SILENCER FILTER					REPLACEMENT ELEMENT
Filter/Silencer Model	For Use With Blower Model:	A Dim. (in.)	B Dim. (in.)	C Dim. (in.)	Replacement Element Model:
FS-123	VFC06-VFC30	6"	6 1/2"	1 1/4" MPT	FS-123E
FS-45	VFC40-VFC50	10"	7 1/4"	1 1/2" MPT	FS-45E
FS-67	VFC60-VFC70	8 5/8"	20 3/8"	2" MPT	FS-67E
FS-89	VFC80-VFC90	12 3/4"	22 1/2"	3" MPT	FS-89E

Typical Pressure System

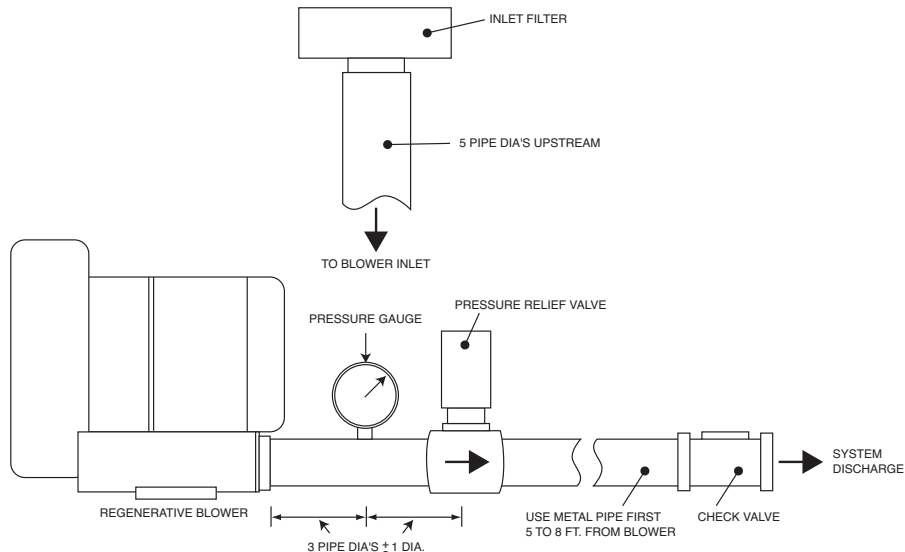

INLET FILTERS/RECEIVERS

Certain applications require an inlet filter and a receiver to retain the dust or debris that is collected during operation. These filters include a fine (.009) mesh screen around which is wrapped a perforated metal outer cover. An additional outer cover made of 100% polyester fibers in a layer about 3/4" thick provides filtration rated 80% efficient at 25 microns. These filters are mounted inside of a receiver, available with either a 15 gallon capacity (18 ga. steel) and 1 1/2" hose connections, or a 30 gallon capacity (16 ga. Steel) and 1 1/2" or 2" hose connections. Hose not included.

Options include a fiberglass screen collection bag to facilitate material removal, and receiver support stand with blower mounting surface (pictured).

These filter / receivers are intended for use with medium weight, low volume materials, wood chips, saw dust, light metal chips, and dirt and dust, where a large filter area is not required.

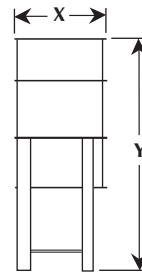

(A) Vacuum flow from receiver to blower; (B) Vacuum flow to receiver; (C) Filter

INLET FILTERS/RECEIVERS			
Part No.	Size	X Dim. (in.)	Y Dim. (in.)
R15P1.5	15 Gallon w/ 1 1/2" inlet and outlet	15	26
R15PS1.5	15 Gallon w/ 1 1/2" inlet and outlet, including stand*	15	40
R15P2	15 Gallon w/ 2" inlet and outlet	15	26
R15PS2	15 Gallon w/ 2" inlet and outlet, including stand*	15	40
R30P1.5	30 Gallon w/ 1 1/2" inlet and outlet	19	30
R30PS1.5	30 Gallon w/ 1 1/2" inlet and outlet, including stand*	19	47
R30P2	30 Gallon w/ 2" inlet and outlet	19	30
R30PS2	30 Gallon w/ 2" inlet and outlet, including stand*	19	47

*Please specify blower model to be used, to ensure correct mounting hole pattern.

FIBERGLASS SCREEN COLLECTION BAG

Model No.	For Use With:
FB15FG	R15P/PS...
FB30FG	R30P/PS...

INLINE VACUUM FILTERS

These filters are designed to protect the Fuji Ring Compressor by filtering the inlet air when the blower is being used for vacuum applications. A metal housing with a removable cover, retained by clamps encloses a pleated paper filter element rated for 10 micron filtration.



REPLACEMENT ELEMENTS

Replacement elements for the Inline Vacuum Filter are pleated paper elements rated for 10 micron filtration. (Other filter elements available upon request. For example: Hepa, etc.)

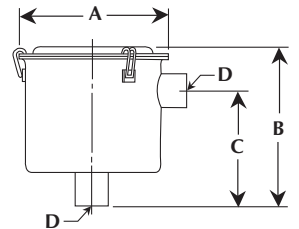

INLINE VACUUM FILTERS						REPLACEMENT ELEMENT
Filter Model	For Use With Blower Model:	A Dim. (in.)	B Dim. (in.)	C Dim. (in.)	D Dim. (in.)	Filter Cover Model:
IVF-01	VFC06-VFC10	5 7/8"	4 3/8"	2 5/8"	1 1/4" FPT	IVF-01E
IVF-23	VFC20-VFC30	7 5/16"	6 1/2"	4 1/2"	1 1/4" FPT	IVF-23E
IVF-45	VFC40-VFC50A/VFC50P	7 5/16"	6 1/2"	4 1/2"	1 1/2" FPT	IVF-45E
IVF-67	VFC60-VFC70	8 3/4"	10 1/4"	5 1/2"	2" FPT	IVF-67E
IVF-89	VFC80-VFC90	14"	27 1/8"	18 1/2"	3" MPT	IVF-89E

Typical Vacuum System

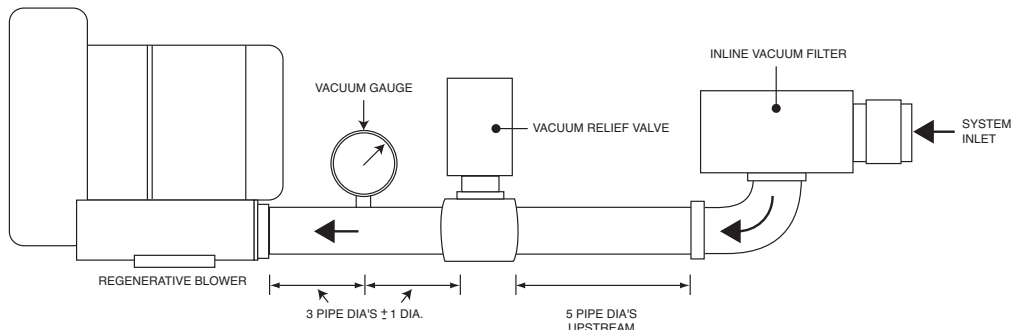

PRESSURE RELIEF VALVES

Most Fuji Ring Compressors should not be operated in a “dead-head” condition. These relief valves are designed to protect the blowers from overheating when operating dead-headed. The valves are preset to provide the proper protection for the appropriate model, which is approximately 90% of the dead-head pressure level, and is adjustable to a lower setting.

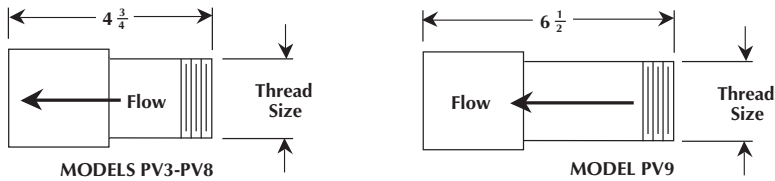

PRESSURE RELIEF VALVES			
Model No.	For Use With Blower Model	Factory Setting (“H ₂ O”)	Thread Size
PV3	VFC30	42	1 1/2” MPT
PV4	VFC40	46	1 1/2” MPT
PV5	VFC50	68	1 1/2” MPT
PV6	VFC60	100	2” MPT
PV7	VFC70	98	2” MPT
PV8	VFC80	127	2” MPT
PV9	VFC90	127	2 1/2” MPT

Typical Pressure System

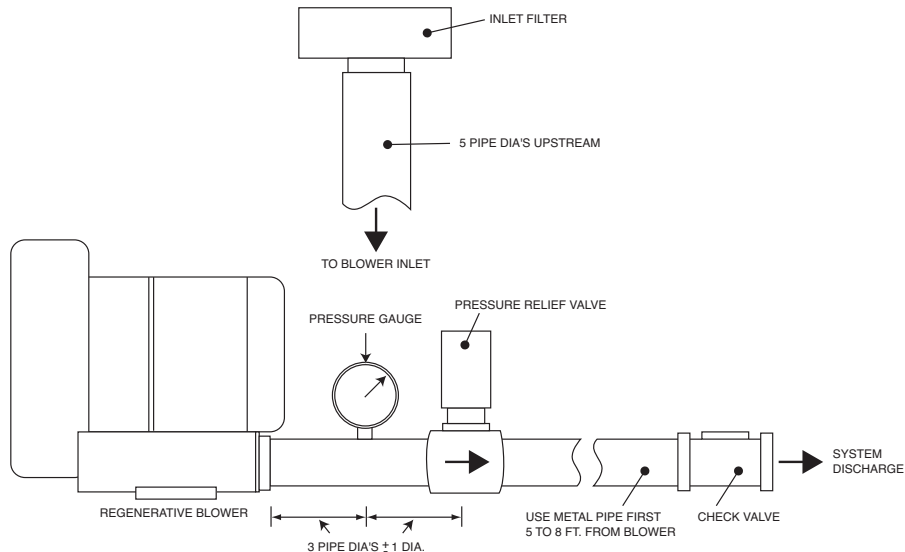

VACUUM BOOSTER

The Vacuum Booster allows utilization of the Fuji Ring Compressor in a zero-flow, or “dead-head” condition for material handling, vacuum pick-up, and other industrial hold-down applications. The vacuum booster permits the necessary flow of cooling air through the blower. Please specify blower model.

Contact the Fuji applications engineering department for assistance in sizing.

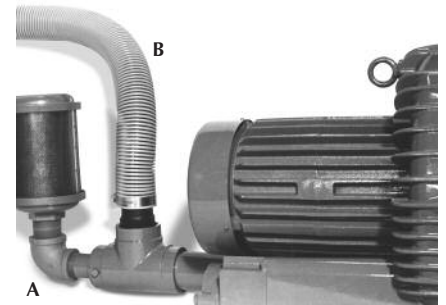

(A) Cooling air flow; (B) Main suction line (may be dead-headed)

VACUUM BOOSTER	
Model No.	For Use With Blower Model:
VB45	VFC40-VFC50
VB67	VFC60-VFC70

VACUUM RECEIVERS

Certain applications require an inlet filter and a receiver to retain the dust or debris that is collected during operation. These filters include a fine (.009) mesh screen around which is wrapped a perforated metal outer cover. An additional outer cover made of 100% polyester fibers in a layer about 3/4" thick provides filtration rated 80% efficient at 25 microns. These filters are mounted inside of a receiver, available with either a 15 gallon capacity (18 ga. steel) and 1 1/2" hose connections, or a 30 gallon capacity (16 ga. Steel) and 1 1/2" or 2" hose connections. Hose not included.

Options include a fiberglass screen collection bag to facilitate material removal, and receiver support stand with blower mounting surface (pictured).

These filter / receivers are intended for use with medium weight, low volume materials, wood chips, saw dust, light metal chips, and dirt and dust, where a large filter area is not required.

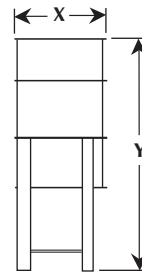

(A) Vacuum flow from receiver to blower; (B) Vacuum flow to receiver; (C) Filter

VACUUM RECEIVERS			
Part No.	Size	X Dim. (in.)	Y Dim. (in.)
R15P1.5	15 Gallon w/ 1 1/2" inlet and outlet	15	26
R15PS1.5	15 Gallon w/ 1 1/2" inlet and outlet, including stand*	15	40
R15P2	15 Gallon w/ 2" inlet and outlet	15	26
R15PS2	15 Gallon w/ 2" inlet and outlet, including stand*	15	40
R30P1.5	30 Gallon w/ 1 1/2" inlet and outlet	19	30
R30PS1.5	30 Gallon w/ 1 1/2" inlet and outlet, including stand*	19	47
R30P2	30 Gallon w/ 2" inlet and outlet	19	30
R30PS2	30 Gallon w/ 2" inlet and outlet, including stand*	19	47

*Please specify blower model to be used, to ensure correct mounting hole pattern.

FIBERGLASS SCREEN COLLECTION BAG

Model No.	For Use With:
FB15FG	R15P/PS...
FB30FG	R30P/PS...

VACUUM RELIEF VALVES

Most Fuji Ring Compressors should not be operated in a “dead-head” condition. These relief valves are designed to protect the blowers from overheating when operating dead-headed under vacuum. The valves are preset to provide the proper protection for the appropriate model, which is approximately 90% of the dead-head vacuum and is adjustable to a lower setting.

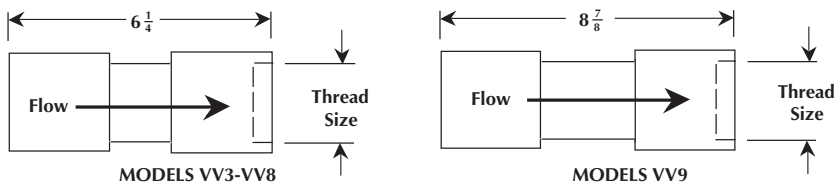

VACUUM RELIEF VALVES			
Model No.	For Use With Blower Model	Factory Setting (“H ₂ O”)	Thread Size
VV3	VFC30	39	1 1/2” FPT
VV4	VFC40	42	1 1/2” FPT
VV5	VFC50	60	1 1/2” FPT
VV6	VFC60	86	2” FPT
VV7	VFC70	85	2” FPT
VV8	VFC80	100	2” FPT
VV9	VFC90	100	2 1/2” FPT

Typical Vacuum System

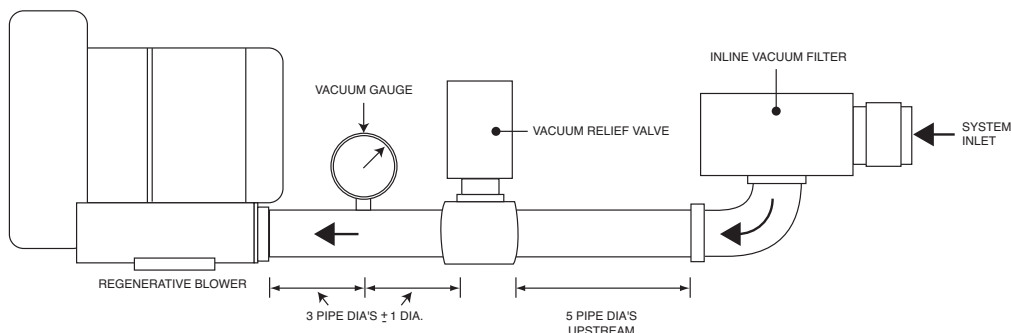



AIR KNIFE

▶ GENERAL GUIDELINES FOR AIR KNIFE APPLICATIONS:

LIGHT BLOW-OFF & DE-STAT APPLICATIONS:

- Velocity Range of 5,300 FPM (Feet per Minute) (60MPH) Minimum to 16,000 FPM (180MPH) Maximum.
- Line speeds will not exceed 100 FPM as a rule.
- Single Pass is all that will be required +90% of applications.

AVERAGE BLOW-OFF APPLICATIONS:

- Velocity Range of 15,000 FPM (170MPH) to 30,000 FPM (340MPH).
- Line speeds up to 150 FPM have better than a 70% chance of requiring only one (1) Pass.
- Line speeds up to 500 FPM. Two (2) Pass or Three (3) Pass system required.

SEVERE BLOW-OFF APPLICATIONS:

- Velocity Range of 25,000 FPM (280MPH) to 53,000 FPM (600MPH).
- Line speeds up to 2,800 FPM (30MPH) could be encountered.
- Multiple Pass systems required +90% of time.

▶ SCENARIOS FOR AIR KNIFE SYSTEM INSTALLATIONS:

BEST:

- Air Knife within 1" of work surface.
- Blower within 10' of Air Knife Station.
- All 90° bends are eliminated.
- Inlet Filters are changed on a regular basis.
- Ambient temperature does not exceed 100°F (39°C).

ACCEPTABLE:

- Air Knife no further than 12" from work surface.
- Blower no further than 50' from Air Knife Station.
- Inlet Filter is changed before blower failure.
- Ambient temperature does not exceed limits of safe blower operation.

DESIGN CONSIDERATIONS

The successful operation of a Fuji Ring Compressor depends upon following certain guidelines when installing the unit.

CORRECT

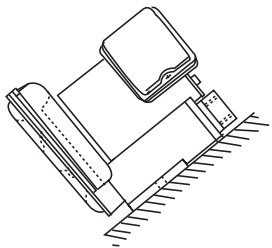
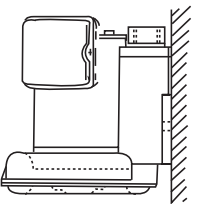
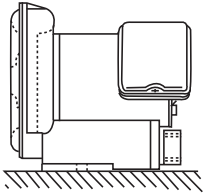

INCORRECT

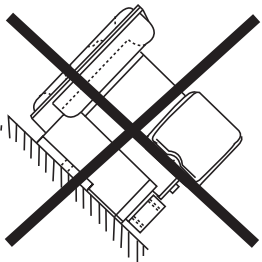
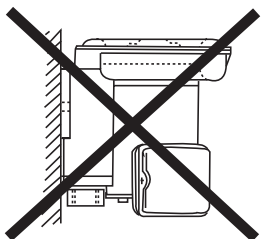

► INSTALLATION

The blowers may be used for handling non-corrosive, non-combustible and nonexplosive gases as well as air. The gas temperature and ambient temperature should be kept at less than 104°F, and the relative humidity at less than 80%.

The blowers can be installed in most directions. When installing the blower with the motor axis mounted vertically or at an angle, it is important to keep the impeller side downward (motor side upward). The VFC70, VFC80 and VFC90 should only be installed with the motor axis mounted horizontally for longer life.

Do not install the Ring Compressors on a base that is subject to vibration. The mounting base should be rigid enough to prevent resonance. Rubber feet, pads, or other vibration absorption materials are recommended.

► SOLID PARTICLES

Gases contaminated by solid particles must be filtered before entering the Blower. Fuji offers a complete line of accessories designed to remove all types of contaminants, which include: Inlet filters for both pressure and vacuum, filter traps, and cyclone separators and receivers. These can be used to prevent dust, dirt, lint, threads, and water from entering the blower inlet.

► DIRECTION OF ROTATION

All Fuji Ring Compressors have an arrow located on the blower housing to indicate the proper direction of rotation, and all blowers operate in a counterclockwise direction when viewed from the motor side. This can be checked by watching the fan on the motor, or by feeling the airflow entering or exiting the

blower inlet and outlet, which are labeled "IN" and "OUT", respectively. All three phase units may have the direction of rotation reversed by switching the two main power leads. All single phase units operate in one direction of rotation only, regardless of wire connections.

When three phase units operate with reversed rotation, a loss of performance will result, and airflow will be reversed. Some applications may benefit from this type of operation; please contact the factory for information.

► TEMPERATURE

The temperature rise of air passing through the blower can be determined from each product's Performance Data Charts.

► CONTINUOUS OPERATION

When operating Fuji Ring Compressors, the air flow can be throttled between the open-flow (0" H₂O pressure difference) to a blank-off condition (zero flow). The blankoff duration of the blower must not exceed the maximum allowable time (3 Phase Wiring Diagrams). If the blower will be operating in a continuous mode, it requires a minimum amount of air flow. Fuji offers pressure and vacuum relief valves that are set at the correct point to allow proper operation of the blower. When using relief valves, the blower must be rotated in one direction only.

Models VFC60-VFC70 and smaller must be limited to 10 starts per hour; models VFC70 and larger must be limited to 4-6 starts per hour, for extended life.

DESIGN CONSIDERATIONS



FUJI ELECTRIC
APPLICATIONS

▶ OPERATING LIMITS

60 HZ OPERATION						
Model	TEMPERATURE		PRESSURE		VACUUM	
	Maximum Outlet Temperature**		Maximum Time at Dead-head (Seconds) ¹	Minimum Airflow (SCFM)	Maximum Time at Dead-head (Seconds) ¹	Minimum Airflow (SCFM)
	°C	°F				
VFC06	70	158	Cont.	0	Cont.	0
VFC08	70	158	Cont.	0	Cont.	0
VFC10	80	176	600	3.5	600	3.5
VFC20	80	176	240	3.5	240	3.5
VFC30	70	158	120	17*	120	16*
VFC40	105	223	120	3.5*	120	3.2*
VFC50	95	205	60	45*	60	40*
VFC60	110	230	60	56*	60	50*
VFC70	115	241	30	88*	30	70*
VFC80	115	241	30	135*	30	106*
VFC90	130	266	30	195*	30	140*

50 HZ OPERATION						
Model	TEMPERATURE		PRESSURE		VACUUM	
	Maximum Outlet Temperature**		Maximum Time at Dead-head (Seconds) ¹	Minimum Airflow (SCFM)	Maximum Time at Dead-head (Seconds) ¹	Minimum Airflow (SCFM)
	°C	°F				
VFC06	70	140	Cont.	0	Cont.	0
VFC08	70	140	Cont.	0	Cont.	0
VFC10	75	169	600	1.75	600	1.7
VFC20	75	169	240	3.5	240	3.5
VFC30	65	151	120	10*	120	9*
VFC40	95	208	120	3.5*	120	3.2*
VFC50	80	176	60	25*	60	23*
VFC60	100	212	60	28*	60	24*
VFC70	100	212	30	63*	30	62*
VFC80	115	241	30	88*	30	87*
VFC90	125	259	30	140*	30	139*

* Use of pressure or vacuum relief valves are recommended. See Vacuum and Pressure Relief Valve Charts.

** Max. outlet temp. = max. temp rise + 40°C (104°F) ambient temp.

¹ Maximum time (seconds) at dead-head starting at ambient temperature.

▶ 1 PHASE WIRING DIAGRAMS

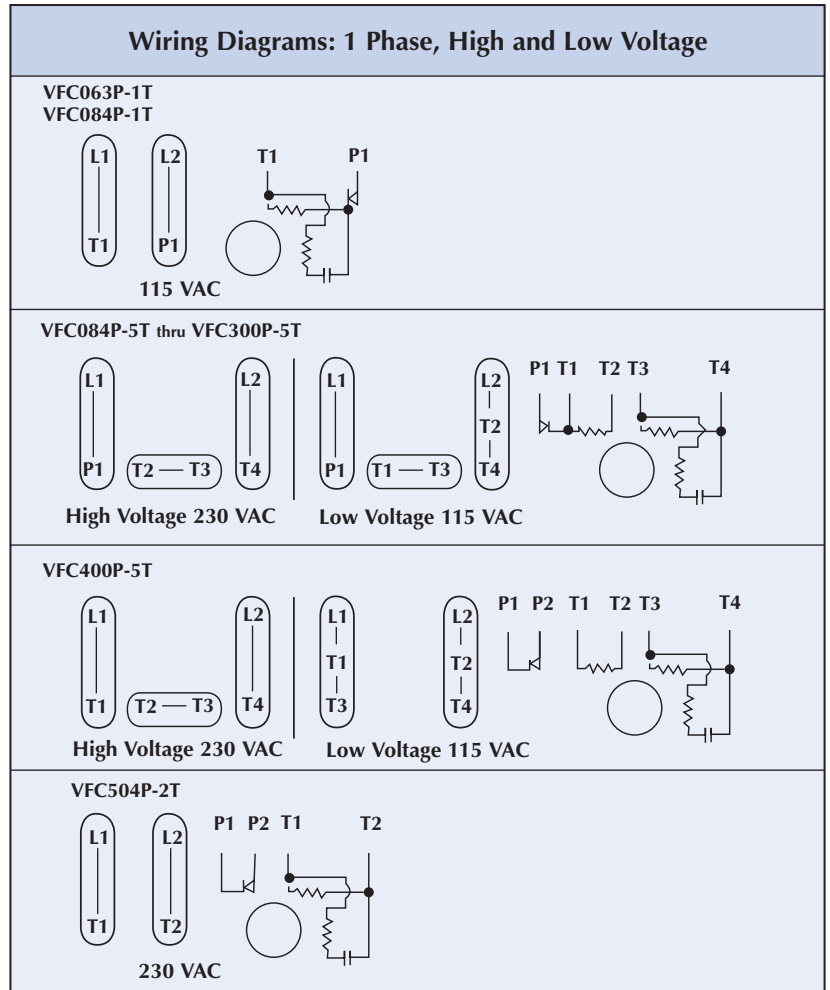
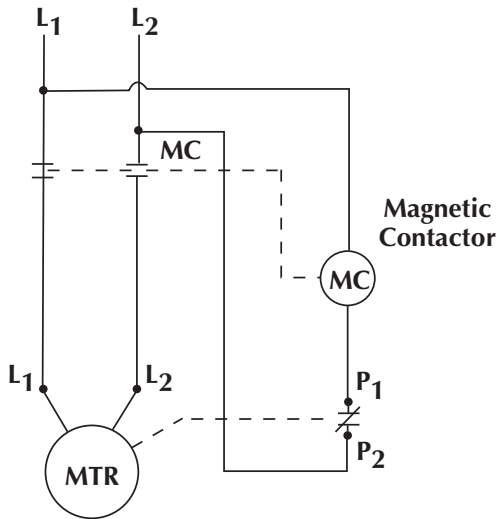

▶ OPERATING VOLTAGE

	Nameplate Voltage	Nominal Operating Voltage (50 Hz)	Nominal Operating Voltage (60 Hz)
1 phase	115 V	110 V	115 V
	230 V	220 V	230 V
3 phase	200-230 V	190-230 V	200-240 V
	460 V	380-460 V	400-480 V
	575 V	-	550-600 V

Note: All wiring must conform to local and national codes. Please contact your local electrical contractor.

▶ 3 PHASE WIRING DIAGRAMS

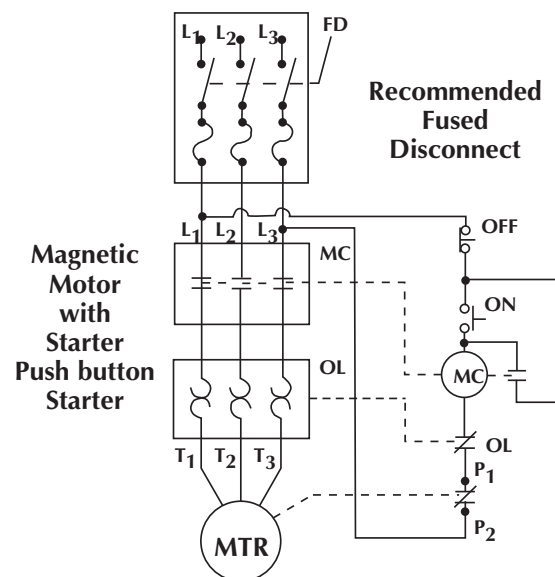
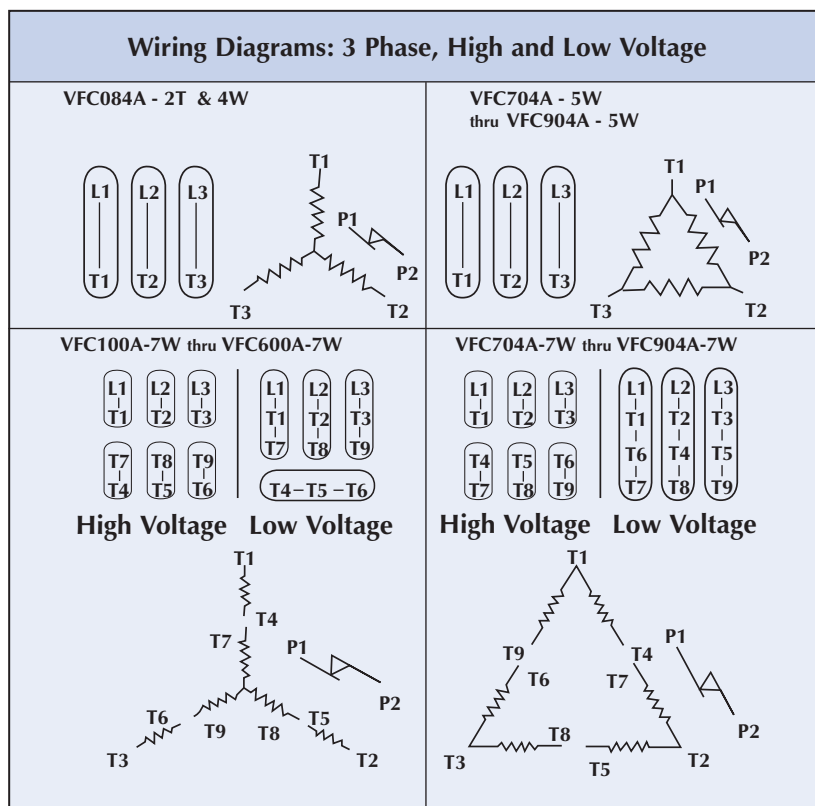

Motor Control Wiring Diagram for all
3 Phase Models for Maximum Protection

▶ AUTOMATIC THERMAL PROTECTION

In models VFC063P, VFC084P, VFC100P, VFC200P, and VFC300P the thermal protector is in direct line with the power to the motor windings. If a thermal overload occurs, the thermal switch opens at $135^{\circ} \pm 5^{\circ}\text{C}$ ($275^{\circ} \pm 9^{\circ}\text{F}$). Power is interrupted to the motor winding; power will be restored when the thermal switch measures $88^{\circ} \pm 15^{\circ}\text{C}$ ($190^{\circ} \pm 27^{\circ}\text{F}$). The motor will resume full speed.

▶ PILOT DUTY THERMAL PROTECTION

In models VFC400P and VFC504P, VFC100A – VFC600, VFC084A – VFC904A, the thermal switch must be put in series with the magnetic starter coil (low current circuit). The thermal switch opens at $135^{\circ} \pm 5^{\circ}\text{C}$ ($275^{\circ} \pm 9^{\circ}\text{F}$) and closes at $88^{\circ} \pm 15^{\circ}\text{C}$ ($190^{\circ} \pm 27^{\circ}\text{F}$). Magnetic contactors and magnetic starters must be reset manually in most cases. Some electrical circuits may vary. Please contact system electrical drawings or a qualified electrician to trouble shoot the circuit.



SPAS AND HOT TUBS

▶ SPAS AND HOT TUBS

Most spas and hot tubs require regenerative blowers to provide the pressure and flow needed to agitate the water. Sizing a blower can be as simple as following these steps:

1. Determine the number of jets orifices in the spa.
2. Calculate the total area of all the orifices.
Total area = (No. of holes) x 3.1416 x radius²
3. Select the proper blower by finding the number and size of the orifices (or jets), making sure that the maximum depth for the blower is not exceeded.

EXAMPLE

Select a blower for a 6' x 6' spa with a depth of three feet, that has (50) 3/16" orifices:

1. Number and size of orifices = 50 x 3/16"
2. Total area of orifices = 50 x 3.1416 x .0942² = 1.39 in.²
3. From the Blower Selection Chart 1.39 in.² is greater than the minimum requirement for a VFC40 blower. The depth of 36" is within the maximum limit for water depth. Therefore, the VFC40 blower should be selected.

ORIFICE AREA CHART	
Orifice Size	Area (in. ²)
1/8" (0.125)	0.012
5/32" (0.156)	0.019
3/16" (0.188)	0.028
7/32" (0.219)	0.038
1/4" (0.250)	0.049

SPA SURFACE AREA CHART (FT. ²)			
Spa Depth	VFC40	BLOWER MODEL	
		VFC50	VFC60
30"	64	105	140
36"	52	98	128
42"	46	92	117
48"	-	86	111

SPAS AND HOT TUBS

FUJI ELECTRIC
APPLICATIONS

NOTES

1. Two 45° ells are preferred to one 90° ell.
2. Install a loop at least 18" above the water level.
3. If back-pressure on the blower is excessive, it may be necessary to add more orifices, or to enlarge the existing orifices.
4. A check valve with a very low pressure drop should be placed in an accessible location, close to the spa.
5. Piping to the spa should be 2" or greater. On runs longer than 50', the first 25' should be 2 1/2" minimum. Due to the discharge temperature from some blowers (depending on operating conditions) PVC pipe may not be a satisfactory material.

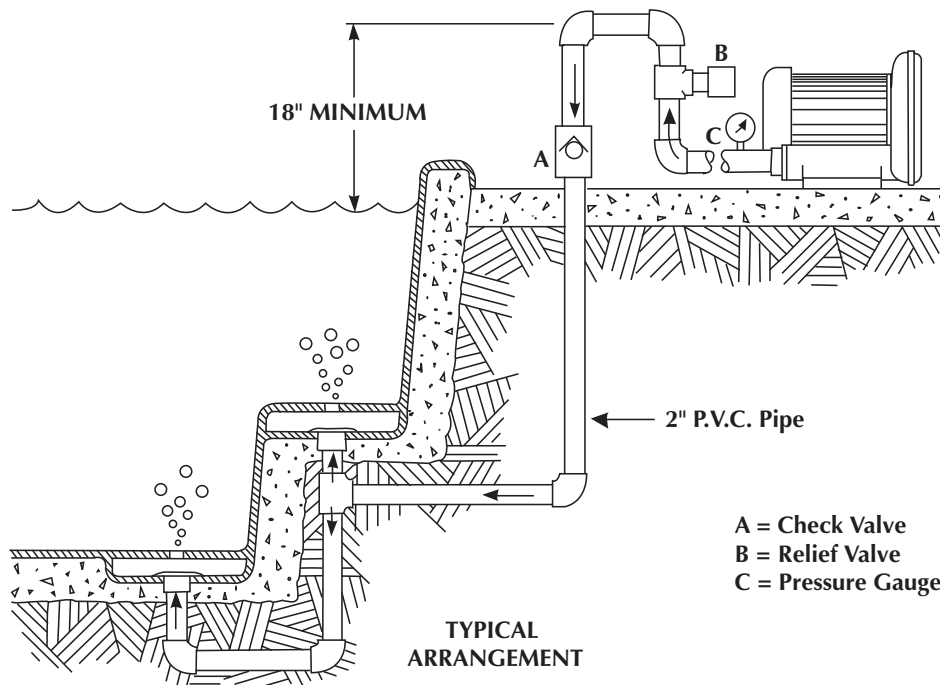

A = Check Valve
B = Relief Valve
C = Pressure Gauge

BLOWER SELECTION CHART

Model	Maximum water depth	Number of jets	Orifice size	Minimum number of orifices	Minimum total hole area (in. ²)
VFC40	42"	3 - 7	1/8"	98	1.2
			5/32"	63	
			3/16"	43	
			7/32"	32	
			1/4"	25	
VFC50	64"	8 - 13	1/8"	162	2.0
			5/32"	105	
			3/16"	72	
			7/32"	53	
			1/4"	41	
VFC60	84"	12 - 17	1/8"	244	3.0
			5/32"	157	
			3/16"	109	
			7/32"	80	
			1/4"	61	



TANK AGITATION

▶ TANK AGITATION

Fuji Ring Compressors are great for applications requiring agitation of fluids in plating tanks, rinsing tanks and cleaning tanks because they offer the following advantages:

- Clean, oil-free air without contaminants to foul or spoil the fluid.
- Low noise levels meet OSHA requirements without costly noise reduction equipment required by positive displacement Roots-type blowers.
- Low operating cost when compared to air compressors.
- Low purchase cost when compared to other types of blowers or compressors.
- Dependability of a rotating machine without wearing, rubbing or sliding components. The only moving part is a non-contacting impeller supported by two high quality ball bearings.

PLATING TANK

Fuji blowers produce agitation that helps renew cathode films, decrease polarization, and allows the use of higher current density, permitting higher plating speeds and finer grain deposits. The air agitation's scrubbing action also minimizes the quantity of rinse water needed, thus reducing the load on water treatment facilities.

CLEANING TANK

End solvent / solution stagnation. With a Fuji blower agitation, fresh solution is constantly brought into contact with the part, removing dirt particles and dissolving grease.

▶ BLOWER SIZE FOR TANK AGITATION

PRESSURE REQUIREMENTS

$$P = 0.43 D S + 0.75$$

Where: P = Pressure (PSIG)
 D = Depth of Solution (Feet)
 S = Specific Gravity of Solution (see table)

FLOW REQUIREMENTS

$$Q = AF$$

Where: Q = Flow Rate (SCFM)
 A = Tank Surface Area (ft.²)
 F = Agitation Factor (SCFM/ft.², see table)

AGITATION FACTOR AND SPECIFIC GRAVITY TABLE

Solution	Agitation Factor (F) (SCFM/ft. ²)	Specific Gravity (D)
Al Plating	1.0 - 1.8	1.2
Cu Plating	1.0 - 1.5	1.2
Ni Plating	1.2 - 2.0	1.2
Cleaning	1.0 - 1.5	1.1
Rinsing	0.5 - 1.5	1.0

TANK AGITATION

EXAMPLE 1

2 copper plating tanks are to be agitated. Tank dimensions are 3'w x 6'l x 4'h with a solution depth of 3.5 feet.

Step 1: Determine the pressure.

$$P = 0.43 \times 3.5 \times 1.2 + 0.75 = 2.6 \text{ PSIG}$$

Step 2: Determine the flow.

$$Q = 2 \text{ tanks} \times 3 \times 6 \times 1.5 = 54.0 \text{ SCFM}$$

Step 3: From the Blower Selection Chart below, read down from 2.5 PSIG to the flow that meets or exceeds 54.0 SCFM, then read left to the proper Fuji blower. In this case, Fuji model VFC50 will provide 60 SCFM.

Note: Use of pressure relief valve or vent valve installed in a "T" to vent excessive air is recommended. This permits cooler operation of the blower, consumes less power and extends life.

TANK AGITATION AND VENTILATION CHART

Model	Pressure PSIG (in. H ₂ O)							
	1 (27.7)	1.5 (41.5)	2.0 (55.4)	2.5 (69.2)	3.0 (83.1)	3.5 (96.9)	4.0 (110.8)	4.5 (124.6)
VFC20	20							
VFC30	35	22						
VFC40	70	45				SCFM		
VFC50	125	100	85	60				
VFC60	175	160	140	125	100	80		
VFC70	230	205	185	165	130	100		
VFC80	360	340	320	290	275	250	210	150
VFC90	515	470	435	390	350	310	260	185

TANK VENTILATION

Many cleaning, plating and rinsing tanks emit toxic fumes that must be removed. Fuji blowers provide air flow across the surface of the tank to transport the fumes to an exhaust system.

BLOWER SIZE FOR TANK VENTILATION

PRESSURE REQUIREMENTS

The typical requirement for ventilation systems is:

Air Flow = 1 SCFM @ 1 PSIG
for each Foot of Tank Length

Orifices should be sized to provide an area equal to that of a 1/8" orifice, or 0.012 in.², per foot of pipe.

EXAMPLE 2

Using the (2) 3' x 6' long tanks in Example 2, the airflow requirement will be: 2 x 6 x 1 = 12 SCFM @ 1 PSIG. Referring to the Blower Selection Chart on page 45 at 1 PSIG, a VFC20 will provide 20 SCFM.

CAUTION

When the blower provides more airflow than required, it should not be throttled. There may be a possibility of damaging the blower due to excessive pressure or insufficient airflow to cool it.