













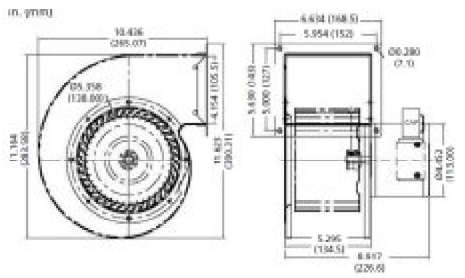

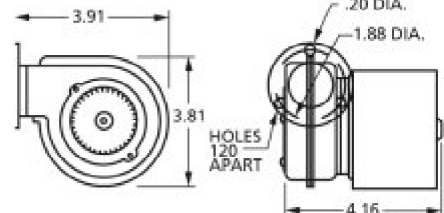



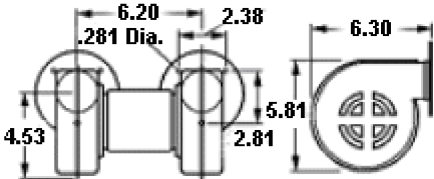

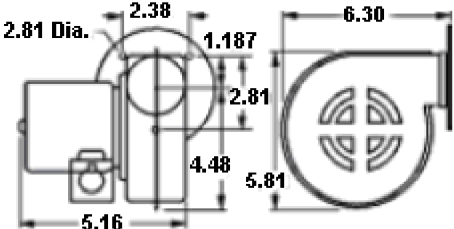

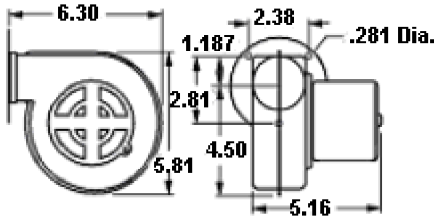

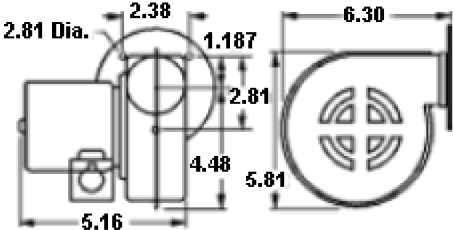

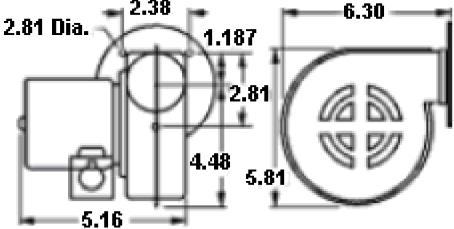
FASCO®



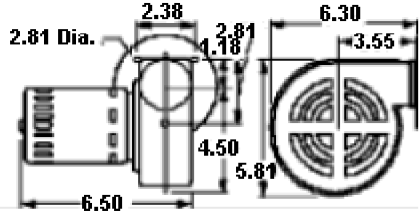

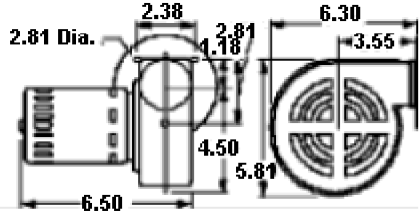
Fasco & Rotom Blowers

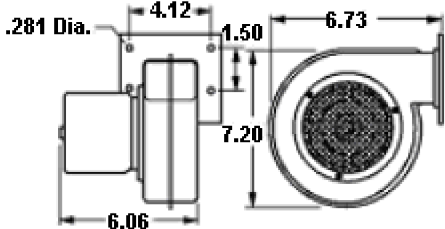

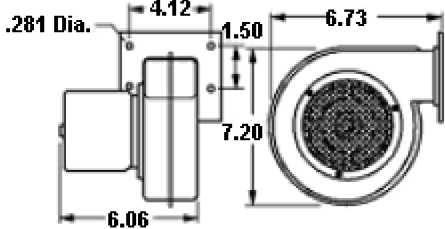

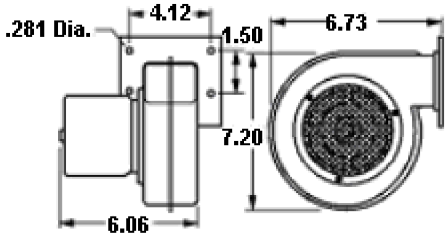

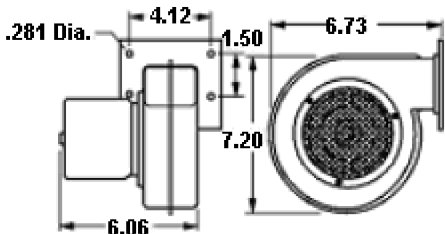
Click Image Enlarge Picture	Catalog #	Description	Dimension Drawing
	HB-RBM121	<ul style="list-style-type: none"> • Whitfield Pellet Stove Blower 12126109 • 1/35hp, 1.5 amps, 115 Volt • 3000 RPM • Rotation = CW • 6" leads with flat connector plug (2 wires) not recommended for speed control mfgr = Rotom 7021-7786, 70217786 702111470, 7021-11470 	<p style="text-align: center;">Outside Flange Dimension = 4 3/8" x 4" Bolt Hole-center to center = 3 3/4" x 3 3/8"</p>
	R7-RB4	<ul style="list-style-type: none"> • .34 amps, 115 Volts • PSC Motor • 3220 RPM, 1-Speed • 100 CFM • TENV • Ball Bearings • mfgr = Rotom • 1 Year Manufacture Warranty <p>Reference: Franklin 76012, 80042, Electrohome EB4</p>	
		<ul style="list-style-type: none"> • 1/25 hp, .60 amps, 115 Volts • 3200 RPM, 1-Speed • 73 CFM • 2 3/4" Shaded Pole Motor 	

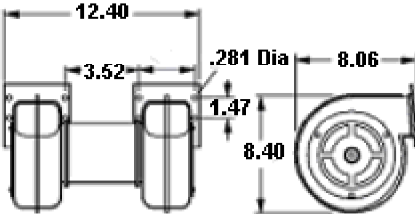

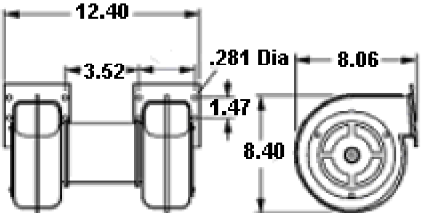

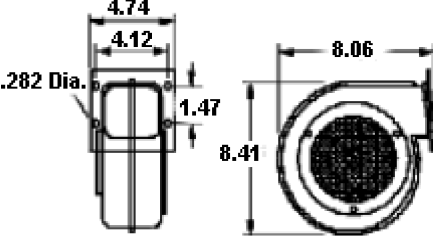
	<p>HB-RB34</p>	<ul style="list-style-type: none"> • 3.3 Shaded Pole Motor • CW Rotation • Sleeve Bearings • 2 3/16" Round Exhaust Outlet • 79" long power cord with 3 prong plug • Screen guard on intake • Built in variable speed control on end of motor • mfgr = Rotom • 1 Year Manufacture Warranty 	<p>3" Square Outlet flange with bolt holes on 2.25" center (square pattern) Large adapter flange 4.5" x 4" with 4 studs on 2.25" center (square pattern-bolts to blower outlet)</p>
	<p>7058-1732</p>	<ul style="list-style-type: none"> • Frymaster OEM Replacement • .80 amps, 115 Volts, 50/60 hz. • 3240 RPM • Ball Bearings not recommended for speed control • 806-4504 SP, 806-4504SP • 7002-0898, 7002-2656 • Kooltronics 807-1245 • Frymaster 106-2994, 826-1512 • For model FPH350CSD 	<p>drawing unavailable</p> <p>Cooling fan on drive end to reduce bearing temperatures</p>
	<p>R7-RB445</p>	<ul style="list-style-type: none"> • Rotom Replacement Blower For Dayton • 1/6hp, 2.2 amps, 115 Volts • 3.3" Diameter Motor • 549 CFM • Ball Bearings • PSC Motor • mfgr = Rotom not recommended for speed control • Dayton Equivalent 4C445, 1TDT2, 4YJ32 • 7090-2378 	
	<p>50745-D500</p>	<ul style="list-style-type: none"> • 3100RPM Shaded Pole Blower • .21 amps @ 115 Volts 60hz. • Name Plate CFM 15 • Dayton equivalent 2C782, 1TDN2 • 7021-1998 not recommended for speed control 	

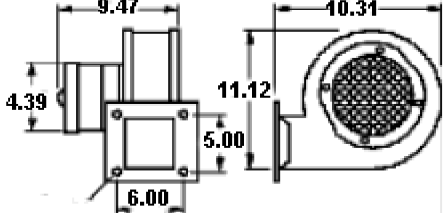

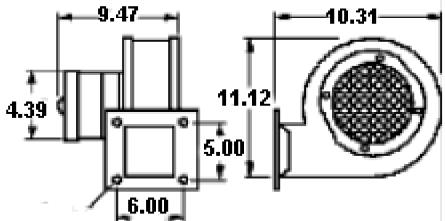

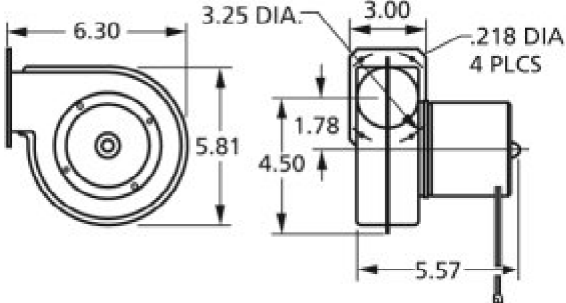

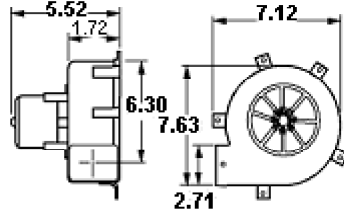
	50746-D500	<ul style="list-style-type: none"> • 3100RPM Shaded Pole Blower • .72 amps @ 115 Volts 60hz. • Name Plate CFM 120 not recommended for speed control 	
	50747-D230	<ul style="list-style-type: none"> • 3200RPM Shaded Pole Blower • .26 Amps @ 208-230 Volts 50/60hz • Name Plate CFM 60 not recommended for speed control 	
	50747-D401	<ul style="list-style-type: none"> • 3200RPM Shaded Pole Blower • .49 amps @ 115 Volts 50/60hz. • Name Plate CFM 60 Dayton 1C180, 4C440, 1TDN7, 7021-3466 6FHX4 7021-7841 (England Stove) 7021-9258 (NESCO) 7021-8768 not recommended for speed control 	
	50747-D500	<ul style="list-style-type: none"> • 3100RPM Shaded Pole Blower • .52 amps @ 115 Volts 60hz. • Name Plate CFM 60 7021-2373 (Birmingham Stove) 7021-4735 (China Metal) 7021-4155, 7121-1641 not recommended for speed control 	
	50747-D600	<ul style="list-style-type: none"> • 3200RPM Shaded Pole Blower • .52 amps @ 115 Volts 60hz. • Name Plate CFM 60 • Outlet O.D = 2.25" • No mounting flange on exhaust not recommended for speed control 	



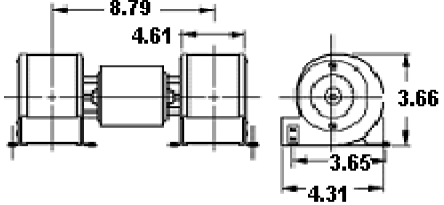

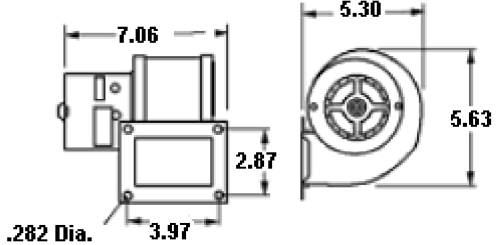

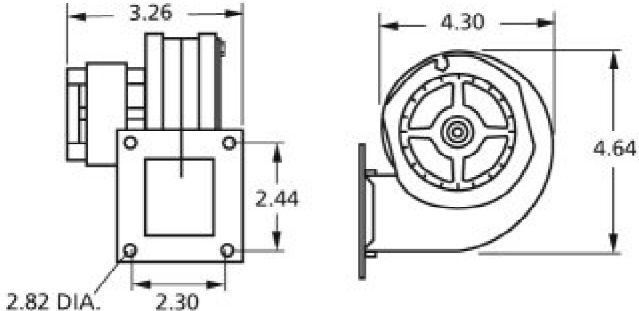
	<p>50748-D500</p>	<ul style="list-style-type: none"> • 2900RPM Shaded Pole Blower • .81 amps @ 115 Volts 60hz. • Name Plate CFM 65 AO Smith BO1065 Dayton 4C443, 1TDP3, 7021-4931 7021-5713, 7021-10870 Dayton 9MRW2 not recommended for speed control 	
	<p>50748-D700</p>	<ul style="list-style-type: none"> • 2900RPM Shaded Pole Blower • .74 amps @ 115 Volts 60hz. • Outlet O.D = 2.25" • Name Plate CFM 65 no On/Off switch • No mounting flange Heat-n-glo 7021-4814 7021-6146, 7121-6146 not recommended for speed control 	
	<p>50752-D230</p>	<ul style="list-style-type: none"> • 3100RPM Shaded Pole Blower • .67 Amps @ 208-230 Volts 50/60hz. • Name Plate CFM 135 • Conduit Box Dayton Equivalent = 2C915, 1TDP6 7021-3483 not recommended for speed control 	
	<p>50752-D500</p>	<ul style="list-style-type: none"> • 3100RPM Shaded Pole Blower • 1.1 amps @ 115 Volts 60hz. • Name Plate CFM 135 Dayton Equivalent = 2C610, 4C442, 1TDP5 7021-3467, 7021-2001, 7021-6745 7021-10838, 7073-0488 Dundas Greenhouse Blower 7021-7857 (coast to coast) 7021-4799 (England Stove) 7058-0383, 80472 not recommended for speed control 	



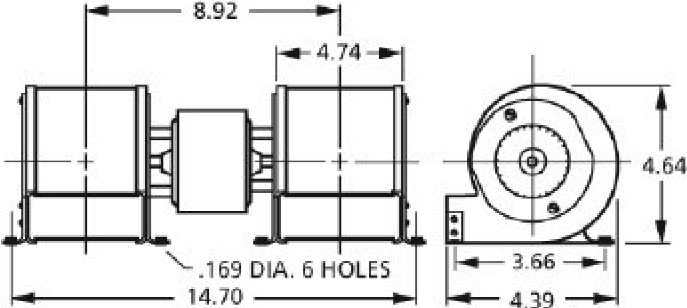

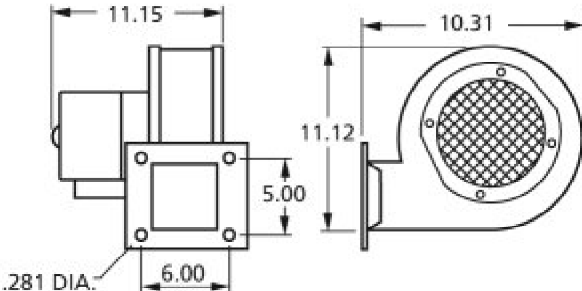

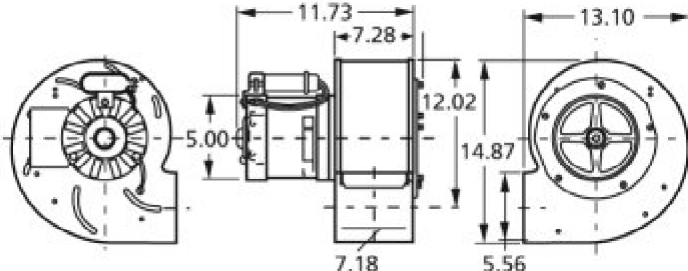
	<p>50755-D230</p>	<ul style="list-style-type: none"> • 1600RPM Shaded Pole Blower • .51 Amps @ 208-230 Volts 50/60hz. • Name Plate CFM 160 <p>Dayton Equivalent = 2C916, 1TDR1 7063-5181 not recommended for speed control</p>	
	<p>50755-D500</p>	<ul style="list-style-type: none"> • 1600RPM Shaded Pole Blower • 1.0 amps @ 115 Volts 60hz. • Name Plate CFM 160 <p>Dayton Equivalent = 1C982, 1TDP9 7063-5313 (Arrow Heating) 7063-8322 (Country Flame) 7063-8285 (Earth Stove) 7063-6692, 7073-0616 (Even Temp.) 7063-9534 (Heat Tech) 7063-3869 (Martin Industries) 7063-5031 (Mt Vernon Fireplace) 7063-9813 (NESCO) 7063-9224 (Regency) 7063-8259 (Trane) 7063-8259, 7063-8571 (Travis) 7073-1480, 7073-1480 (US Stove) 7063-5921 (Waterford Stove) 7063-8537, 7063-8873, 7073-0616 Also used as # 80472A US Pellet Stove Blower</p> <p>not recommended for speed control</p>	
	<p>50756-D230</p>	<ul style="list-style-type: none"> • 1500RPM Shaded Pole Blower • .65 Amps @ 230 Volts 50/60hz. • Name Plate CFM 320 <p>not recommended for speed control</p>	

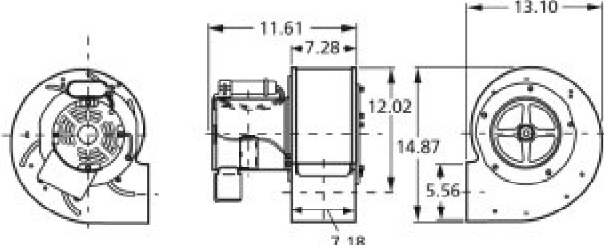

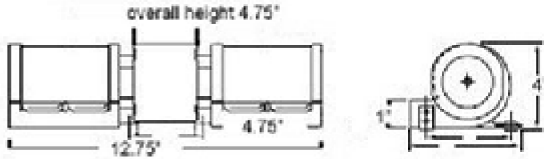

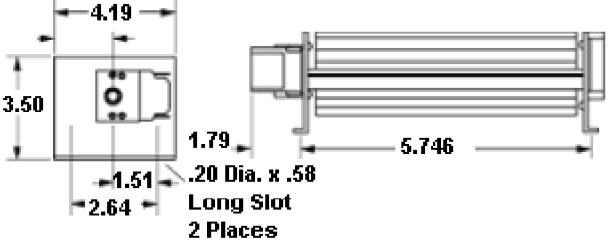

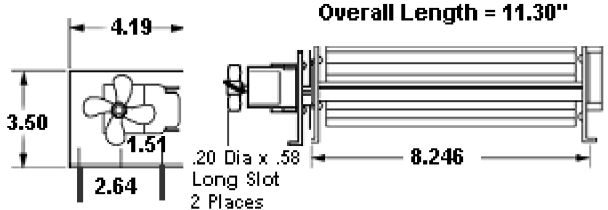
	<p>50756-D500</p>	<ul style="list-style-type: none"> • 1500RPM Shaded Pole Blower • 1.3 amps @ 115 Volts 60hz. • Name Plate CFM 320 Dayton Equivalent = 2C069, 1TDR5 7063-7444 not recommended for speed control 	
	<p>50757-D500</p>	<ul style="list-style-type: none"> • 1560RPM Shaded Pole Blower • .55 amps @ 115 Volts 60hz. • Name Plate CFM 105 • Motor mounted inside blower housing 7063-5366 7063-8322 (Country Flame) not recommended for speed control 	
	<p>50769-D230</p>	<ul style="list-style-type: none"> • 1400/1200RPM Shaded Pole Blower • 1.9 Amps @ 208-230 Volts 50/60hz. • Name Plate CFM 480 Dayton 4C870, 1TDT3, 7008-6481 not recommended for speed control 	
	<p>50769-D500</p>	<ul style="list-style-type: none"> • 1400/1200RPM Shaded Pole Blower • 3.55 amps @ 115 Volts 60hz. • Name Plate CFM 480 George Mayer 7008-6357 Mt Vernon Fireplace 7008-6059 7008-6319, 7108-6084, 7008-6084 7008-6133 7008-6033 (use on hi speed) Dayton 4C444, 1TDR7, 7008-6162 9C404 not recommended for speed control 	

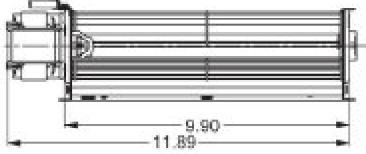

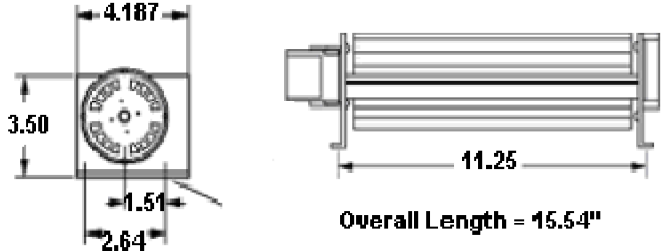
	<p>A071</p>	<ul style="list-style-type: none"> • 2850 RPM • 0.7 amps @ 115 Volts 60hz. • Sleeve Bearings • Name Plate CFM 71 • Includes Power Cord <p>Reference: 7021-7371 not recommended for speed control</p>	
	<p>A082</p>	<ul style="list-style-type: none"> • 2800 RPM • .95 amps @ 115 Volts • Name Plate CFM 75 • 30" Lead Wires • No Gasket Included <p>AO Smith # 9469 7021-9457, 7021-11027, 7021-8181 7021-9667, 7021-7757, 7058-0225 7021-7372, 7121-7586, 7021-8030 7002-1942, 7002-2411, 7021-10215 7021-10216, 7021-10309, 7021-10327 7021-10511, 7021-10725, 7021-11027 7021-11358, 7021-7290, 7021-7856 7021-7850, 7021-7908, 7021-8129 7021-8215, 7021-8286, 7021-8855 7021-9037, 7021-9038, 7021-9081 7021-9527, 7021-9778, 7058-0064 7058-0225, 7021-8165, 7021-7586 7121-8293, 7021-8293 7021-9457 (one speed only) not recommended for speed control</p>	
	<p>A120</p>	<ul style="list-style-type: none"> • 3000 RPM • 1.1 amps, 120 volts • 2-Speed • Ball Bearings • CW Rotation <p>Aladdin Steel/Hearth & Home models 230-1460, 7002-2983 not recommended for speed control</p>	<p>drawing unavailable Dimensions: 12.75" x 4.5" x 4.5" Flanges: 4.75" x 1 5/8"</p>

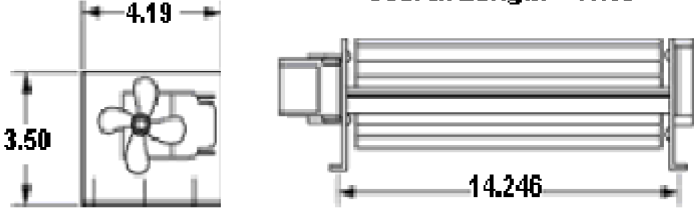

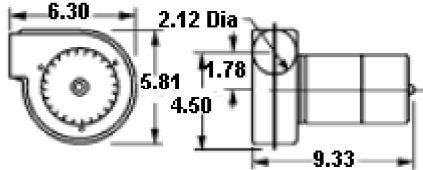
	<p>A125</p>	<ul style="list-style-type: none"> • 3200RPM Shaded Pole Blower • 1.1 amps @ 115 Volts 60hz. • Name Plate CFM 125 • Low Profile Blower <p>7021-10749, 7021-10183, 7021-6791 7021-6809, 7021-7809, 7021-6375 7021-6380 not recommended for speed control</p>	
	<p>A166</p>	<ul style="list-style-type: none"> • 3160 RPM Shaded Pole Blower • 1.50 amps @ 115 Volts 60hz. • 145 CFM • Sleeve Bearings <p>This is the original 4C446 for Dayton 4C005, 4C446, 1TDP7, 7021-3469 7021-6741 not recommended for speed control</p>	 <p>inside dimension of outlet: 3 1/4" x 2 1/8" approx.</p>
	<p>A167</p>	<ul style="list-style-type: none"> • 2900 RPM Shaded Pole Blower • 0.4 amps @ 115 Volts 60hz. • 30 CFM • Sleeve Bearings <p>Reference: 7002-3388 not recommended for speed control</p>	
	<p>A133</p>	<ul style="list-style-type: none"> • 3000RPM Shaded Pole Blower • 1.2 amps @ 115 Volts 60hz. • Power cord 24" with 2-prong plug • Heat N Glow 7002-1241 <p>7002-2944, 7102-2944, 7002-2311, 7002-2143 7002-1615, 7102-1615 not recommended for speed control</p>	<p>drawing unavailable</p> <p>Length: 12 7/8" Height: 4 3/8" Width: 4" Flange Opening: 4 3/4" x 1"</p>

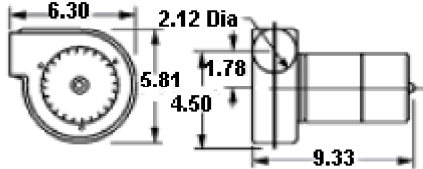

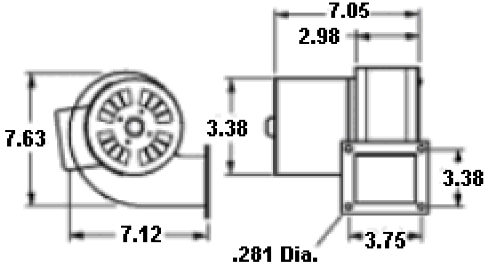

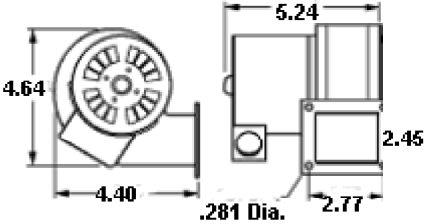
	<p>A212</p>	<ul style="list-style-type: none"> • 3000RPM Shaded Pole Blower • 1.25 amps @ 115 Volts 60hz. • Name Plate CFM 212 7021-10550, 7021-7624, 7021-7931 7021-9025 not recommended for speed control 	 <p>Flange = 4 5/8" x 1 5/8"</p>
	<p>A455</p>	<ul style="list-style-type: none"> • 1500/1100 RPM; 2-Speed • 1.5 amps @ 115 Volts 60hz. • Name Plate CFM 455 • Sleeve Bearings AO Smith # 9478, JE2K017 not recommend for speed control 	
	<p>A1000</p>	<ul style="list-style-type: none"> • 1100 RPM; 2-Speed • 2.9/1.4 Amps @ 115/230 Volts • Name Plate CFM 1000 • Sleeve Bearings Reference 7151-2676 not recommend for speed control 	
	<p>A1200</p>	<ul style="list-style-type: none"> • 1500 RPM; 2-Speed • 6.8/3.4 amps @ 115/230 Volts • Name Plate CFM 1200 • Sleeve Bearings not recommended for speed control 	

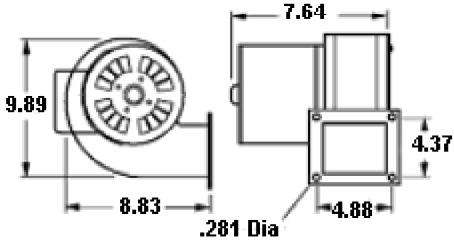

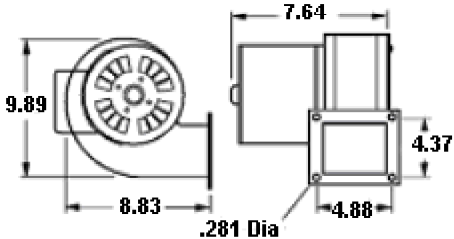

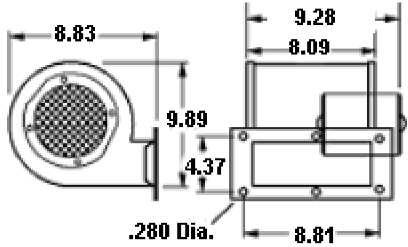
	<p>B160</p>	<ul style="list-style-type: none"> • Low Profile Blower • 3000 RPM • 1.56 amps @ 115 Volts 60hz. • Name Plate CFM 150 • Magnetic Strip on back of mount • Sleeve Bearings • Kit contains speed control/thermal switch • 2 prong plug <p>Fits: Heat n Glo - GFK-160A Royal - GFK-160A Regency Wood Stove Insert Rotom R7-RB168</p> <p>Instructions</p>	
	<p>B22505</p>	<ul style="list-style-type: none"> • Transflo Blower • 3200RPM Shaded Pole Blower • .55 amps @ 115 Volts 60hz. • Name Plate CFM 80 <p>not recommended for speed control</p>	
	<p>B22507</p>	<ul style="list-style-type: none"> • Transflo Blower • 3100RPM Shaded Pole Blower • .85 amps @ 115 Volts 60hz. • Name Plate CFM 115 <p>not recommended for speed control</p>	
	<p>B22508</p>	<ul style="list-style-type: none"> • Transflo Blower • 1500RPM Shaded Pole Blower • .7 amps @ 115 Volts 60hz. • Name Plate CFM 105 <p>(Ref. 101584 fireplace blower)</p> <p>not recommended for speed control</p>	

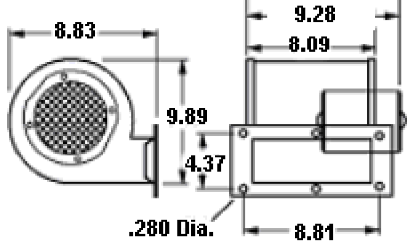
	<p>B22510</p>	<ul style="list-style-type: none"> • Transflo Blower • 3100RPM Shaded Pole Blower • 1.0 amps @ 115 Volts 50/60hz. • Name Plate CFM 153 not recommended for speed control 	
	<p>B22513</p>	<ul style="list-style-type: none"> • Transflo Blower • 2780RPM Shaded Pole Blower • 1.3 amps @ 115 Volts 60hz. • Name Plate CFM 215 Replaces AO Smith J513 not recommended for speed control 	
	<p>B23617</p>	<ul style="list-style-type: none"> • Centrifugal Blower • 3100RPM Shaded Pole Blower • .9/.45 amps @ 115/230 Volts 60hz. • Name Plate CFM 70 Cross Reference Information: Franklin 80270, 7021-10288 4MH41 not recommended for speed control 	
	<p>B23618</p>	<ul style="list-style-type: none"> • Centrifugal Blower • 3100RPM Shaded Pole Blower • .9/.45 amps @ 115/208-230 Volts 50/60hz. • Name Plate CFM 70 • Includes centrifugal switch Cross Reference Information: 7021-8034 7021-5932 Goodman 7021-9000 Fedders 031-7059, 80270 Franklin 7021-10289, 4MH42 not recommended for speed control 	

	<p>B24220</p>	<ul style="list-style-type: none"> Centrifugal Blower 2600 RPM Shaded Pole Blower 1.3 amps @ 115 Volts 60hz. Name Plate CFM 135 Dayton 4C006, 1TDR6, 7021-4933 7021-8249 (Sherwood / Enviro) 7021-8711, 7021-7301, 7021-7758 7021-7788 (check holes) 7021-8844, 7021-7462, 7021-7582 7021-7938 not recommended for speed control 	
	<p>R7-RB3</p>	<ul style="list-style-type: none"> Rotom Brand CFM 75; 3.3" diameter motor 1 Speed, 3220 RPM 0.34 amps, 115 Volts CW Rotation Permanent Split capacitor Open Drip Proof Ball Bearings 	
	<p>B30</p>	<ul style="list-style-type: none"> Centrifugal Blower 3200RPM Shaded Pole Blower .59 amps @ 115 Volts 60hz. Name Plate CFM 45 Dayton 4C012, 1TDN5, 7021-3486 7021-4604, 7021-5599, 7021-5593 7002-1668, 7021-7655 7121-2366, 7021-2366 not recommended for speed control <p>Unit no longer is no longer supplied with a screen, Fasco obsoleted it.</p>	
		<ul style="list-style-type: none"> Centrifugal Blower 1650RPM Shaded Pole Blower 1.86 amps @ 115 Volts 60hz. Name Plate CFM 265 Sleeve Bearings Dayton Equivalent = 4C447, 1TDR3 AO Smith Equivilent 459A 7063-3277 Replacement motor = D1161 	

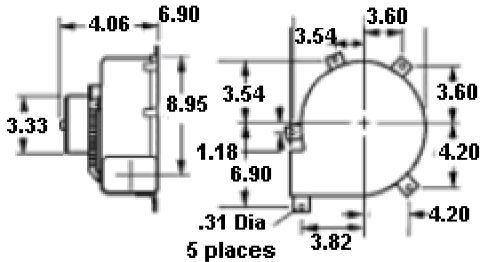
	<p>B45227</p>	<p>Replacement Motor for B45227 7063-4794 (Arrow Heating) 7073-0107 (Earth Stove) 7073-1449 (England) 7063-4996 (National Steel) 7063-4769 (National Stoveworks) 7063-6345 (Nor Aire Mfg.) 7063-6861 (Orville Products) 7063-4777 (Peacock Stove) 7063-4755 (Russo Woodstove) 7063-4996 (Steelcrafters) 7063-6861 (Orville Products) 7063-7102 (US Stove) 7063-7529 (Vestal Mfg) 7063-4824, 7163-4824, 7063-4343 7063-3324, JA29107, JA2P122, JA2P195 not recommended for speed control</p>	
	<p>D1161</p>	<ul style="list-style-type: none"> • 1/15hp • 1480 RPM, 2-Speed • 2.9 amps, 115 volts • Shaft: 5/16" x 2" • Motor Diameter 3.3" • Rotation: CCW Shaft End <p>not recommended for speed control</p>	<p>Replacement Motor for B45227 Blower</p>
	<p>B45227-2</p>	<ul style="list-style-type: none"> • Centrifugal Blower • 1650RPM Shaded Pole Blower • .93 Amps @ 230 Volts 50/60hz. • Name Plate CFM 265 <p>Dayton Equivalent = 4C869, 1TDR4 7063-7019, 7063-7072 not recommended for speed control</p>	

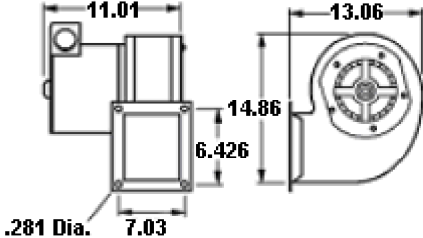
	<p>B45230</p>	<ul style="list-style-type: none"> Centrifugal Blower - 2 Speed 1600/1400RPM Shaded Pole Blower 1.2 Amps @ 208-230 Volts 50/60hz Name Plate CFM 460 7063-3515 not recommended for speed control 	
  <p>Motor View</p>	<p>B45267</p>	<ul style="list-style-type: none"> Centrifugal Blower - 2 Speed 1600/1400RPM Shaded Pole Blower 2.9 amps @ 115 Volts 60hz. Name Plate CFM 460 Dayton Equivalent = 4C264, 4C448 7063-5176 Replacement motor = AO Smith #563, BO1460 7063-6002 (Heatilator) 7063-7942 (Heat-N-Glo) 7063-6341 (England) George Mayer 7063-5329 Mt Vernon Fireplace 7063-5602 Nor-Aire Mfg 7063-6344, 7063-6345 7063-6406 (Travis), 7063-8346 (Ruegg Fireplace) 7063-7871 (US Stove) 7063-5034, 7063-5093 7063-5128 (use on High Speed) not recommended for speed control 	 <p>Flange outside dimensions 9.5" x 5"</p>
	<p>563</p>	<ul style="list-style-type: none"> 1/15hp 1630 RPM, 2-Speed 2.9 amps, 115 volts Shaft: 5/16" x 2 1/2" Motor Diameter 3.3" Rotation: CW Lead End not recommended for speed control 	<p>Replacement Motor for B45267 Blower 7063-3108, 7063-5176, 7063-6169, 7163-3108, 7163-5176 87934057, D1161, 8254110480, JA2R225</p>
		<ul style="list-style-type: none"> Draft Inducer - 3 Speed 1360/1100/830 RPM Shaded Pole Blower 3-Speed 1.95 amps @ 115 Volts 60hz. 	

	<p>B47120</p>	<ul style="list-style-type: none"> Name Plate CFM 160/144/112 7063-7662, 7063-5986, 7063-6207 Appalachian Stove Dayton Equivalent = 4C754, 1TDR2 7063-5673, 7163-7576 Heatilator 7063-6596 7063-6568 (Hutch Mfg) 7063-8057 (Martin Industries) 7063-9465 (Pacific Energy) 7063-5996 (Rockhill Metal) 7063-5957 (US Stove) 7063-6512 not recommended for speed control 	
	<p>B68042</p>	<ul style="list-style-type: none"> Centrifugal Blower 1100RPM Shaded Pole Blower 5.6 amps @ 115 Volts 60hz. Name Plate CFM 815 not recommended for speed control 	
	<p>B75</p>	<ul style="list-style-type: none"> Centrifugal Blower 3000RPM Shaded Pole Blower .59 amps @ 115 Volts 60hz. Name Plate CFM 75 Dayton 4C004, 1TDP1, 7021-3484 Franklin Cast Products 7021-4772 7021-4797 7021-5757 (Welenco) 7021-2367 not recommended for speed control 	