

# CENTRIFUGAL BLOWERS



## 64 to 1200 Free Air Output



**A064**

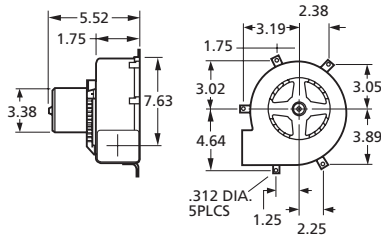

**A079**

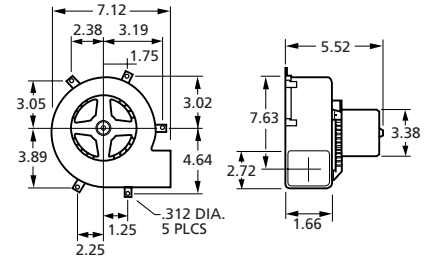

**A080**

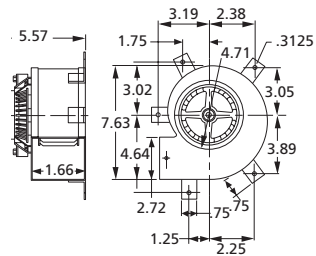

**A090**

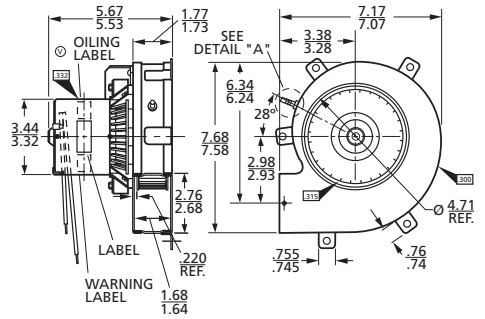

**A118**

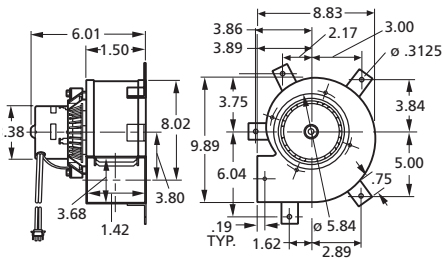

**B24220**

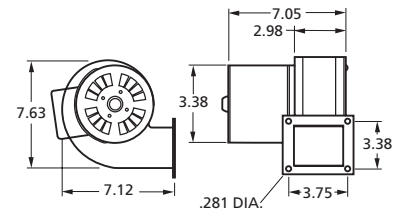

**A1200**

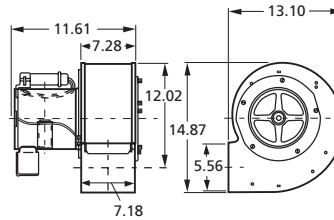

| CFM at Static Pressure Shown |           |           |           |          |          |         |         |         |    |     |     |     | Nameplate CFM | Volts   | Freq. | No. of Speeds | RPM@ Free Air | Amps@ Free Air | MODEL  |
|------------------------------|-----------|-----------|-----------|----------|----------|---------|---------|---------|----|-----|-----|-----|---------------|---------|-------|---------------|---------------|----------------|--------|
| 0.2                          | 0.4       | 0.6       | 0.8       | 1        | 1.2      | 1.4     | 1.6     | 1.8     | 2  | 2.2 | 2.4 | 2.6 |               |         |       |               |               |                |        |
| —                            | 66        | 65        | 64        | 58       | 48       | 25      | —       | —       | —  | —   | —   | —   | 64            | 115     | 60    | 1             | 2400          | .65            | A064   |
| 78                           | 75        | 72        | 68        | 63       | 60       | 47      | —       | —       | —  | —   | —   | —   | 80            | 115     | 60    | 1             | 2100          | 1.1            | A080   |
| 85                           | 81        | 77        | 73        | 65       | 51       | 22      | —       | —       | —  | —   | —   | —   | 89            | 115     | 60    | 1             | 2200          | 1.1            | A079   |
| 86                           | 84        | 78        | 73        | 66       | 57       | 24      | —       | —       | —  | —   | —   | —   | 90            | 115     | 60    | 1             | 2300          | 1.1            | A090   |
| 112                          | 110       | 106       | 102       | 97       | 90       | 83      | 73      | 60      | 39 | 22  | 18  | 10  | 118           | 115     | 60    | 1             | 2600          | 1.8            | A118   |
| —                            | 140       | 130       | 120       | 110      | 45       | 22      | —       | —       | —  | —   | —   | —   | 135           | 115     | 50/60 | 1             | 2600          | 1.3            | B24220 |
| 1260/1065                    | 1240/1060 | 1200/1050 | 1150/1000 | 1075/950 | 1000/900 | 925/800 | 800/675 | 200/200 | —  | —   | —   | —   | 1200          | 115/230 | 60    | 2             | 1500/1400     | 8-6.8/4-3.4    | A1200  |