

NEMA Premium
IE3

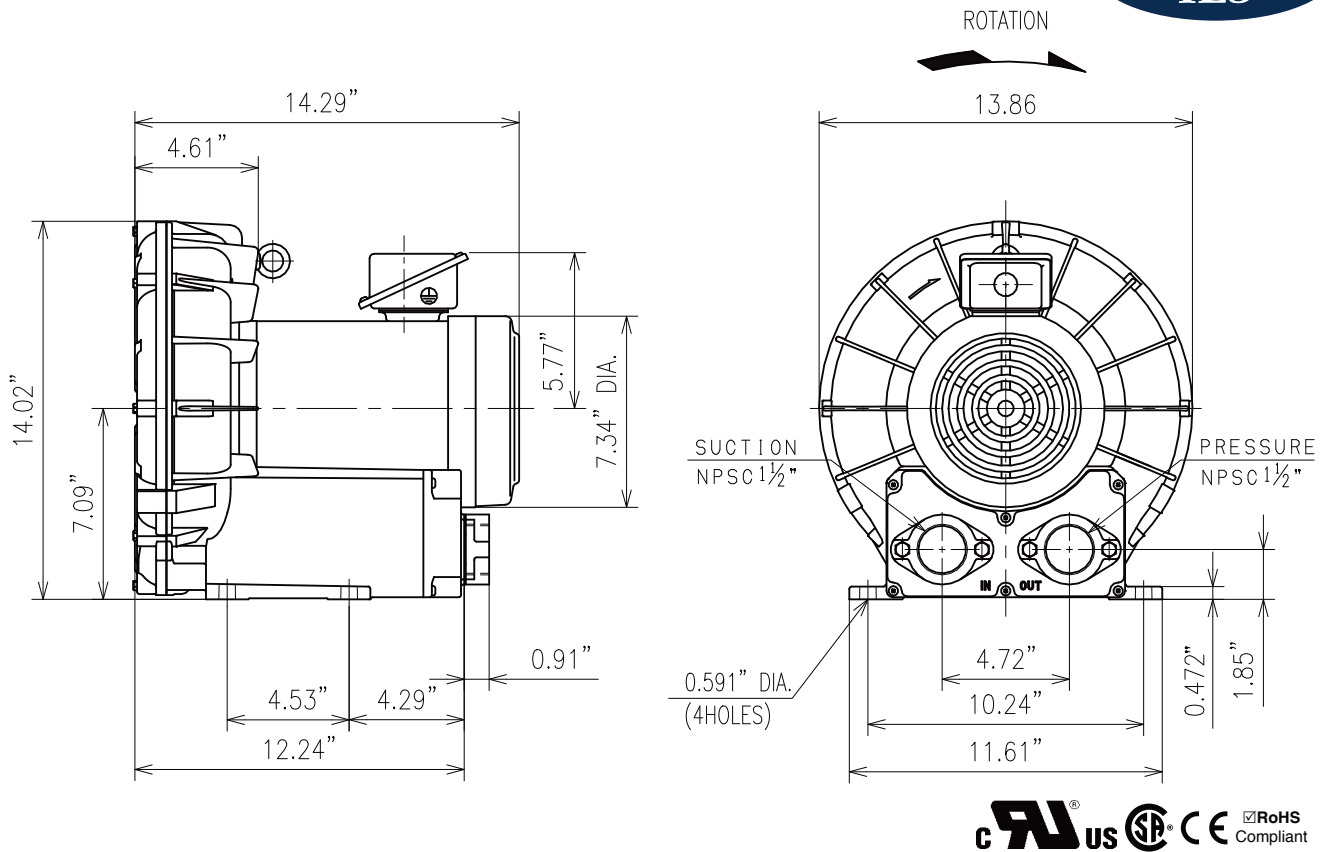

UL **us** **CSA** **CE** **RoHS** Compliant

Specifications

Model	VFZ501A-7W	
HP	2.7HP	2.0HP
Hz	60	50
Phase	3	3
Voltage	208-230/460	200/400
Max. Amps	7.8-7.4/3.7	6.5/3.8
Locked Rotor Amps	69-76/38	71/35.5
Max. Pressure (in. H2O)	80	61
Max. Vacuum (in. H2O)	78	54
Max. Airflow Pressure (SCFM)	135	113
Max. Airflow Vacuum (SCFM)	134	105
Min. Airflow Pressure (SCFM)	45	7
Min. Airflow Vacuum (SCFM)	0	0
Max. Air Temperature Rise (°F)	118	118
Weight (lbs.)	77	77

Pressure

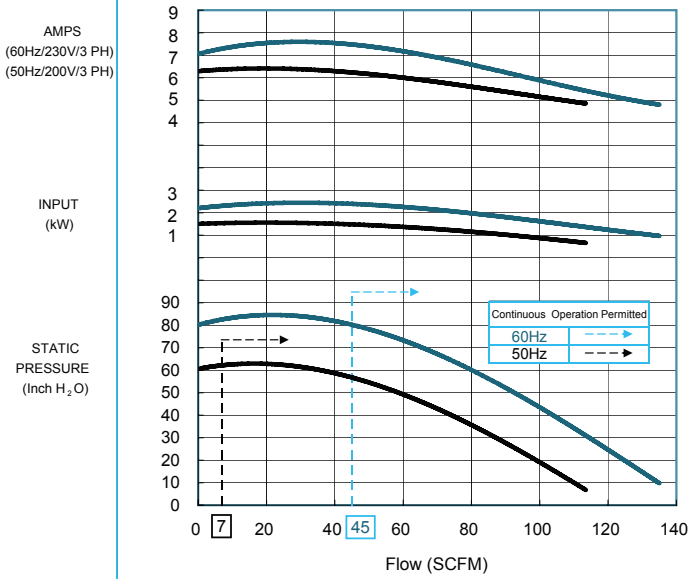

Vacuum

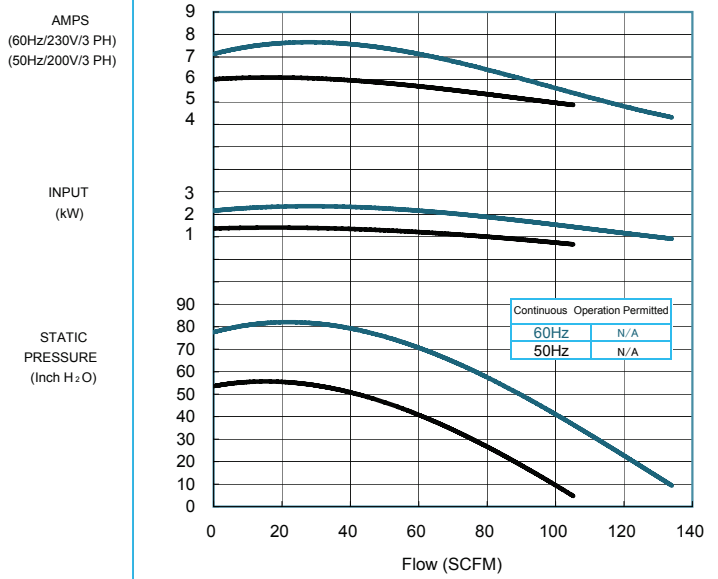

Temperature Rise

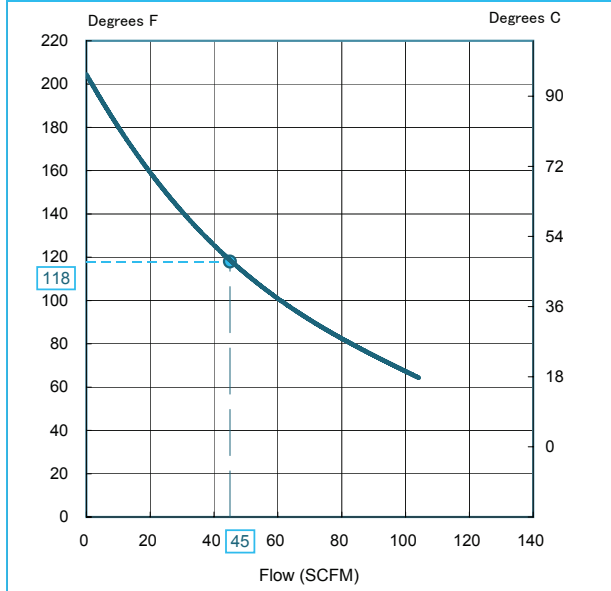

Max Air Temperature is Value Marked •
Plus 40 Degrees C Ambient Temperature

Accessories

Inlet Filter	F-45
Inlet Filter/ Silencer	FS-45
In-Line Vacuum Filter	IVF-45
Pressure Relief Valve	PV5
Vacuum Relief Valve	Not Required
Silencer 1-1/2"	VFY024A